

TRILUX
SIMPLIFY YOUR LIGHT.

RAIL

INVISIBLE CONNECTION. VISIBLE IMPACT.

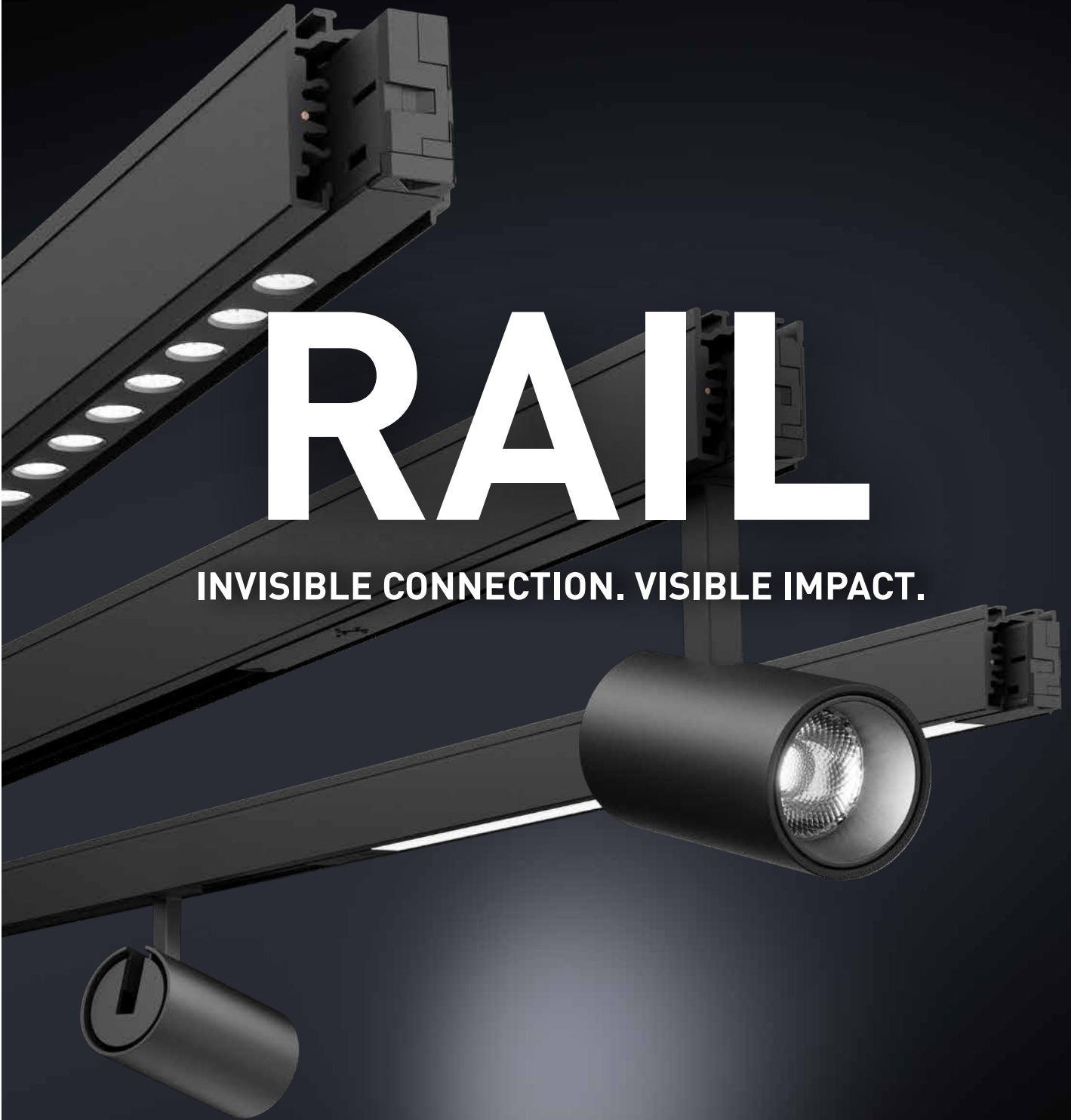



RAIL INVISIBLE CONNECTION. VISIBLE IMPACT.

Accentuating, emotional light is a decisive element in the design of hybrid working environments. Rail is the perfect system for this: it provides the extremely flexible basis for attractive and adaptive lighting concepts – including smart connectivity.

With flush inserts and adapters, Rail as 230 V track is as elegant and minimalist as otherwise only low voltage track systems can be. Various mounting options, a wide range of accessories and a large selection of suitable luminaires enable customised solutions for office concepts with high atmospheric requirements.



Content

Rail – 230 V track system	02
Luminaire inserts	08
Planning examples	16
Customisation	20
Mounting options	21
Product overview	26
Your TRILUX contact	30

FLEXIBLE ELEGANCE FOR THE OFFICE

With its optimised design, track conquers the office: Rail bundles flexible power supply and control lines for luminaires in a slender aluminium profile. Flush invisible adapters and inserts as well as the high-quality fine surface structure emphasise the elegant effect in the space.

High-quality fine structure

Flush Invisible Drivers

SMART AND POWERFUL

As 230 V track, Rail does not require a separate converter, enables long distances without voltage losses and always has enough power reserve for the higher luminous fluxes in office applications. The profile contains 6 conductors for 3 separately switched luminaire groups and DALI control lines for light management, for example LiveLink. Alternatively: wireless control with Casambi.

IN LINE WITH THE SPATIAL CONCEPT AND ARCHITECTURE

Rail is extremely versatile and easy to plan: it can be mounted on ceilings or walls, installed in suspended ceilings or plastered in. If suspended, it can also illuminate indirectly. Rail is available in black and white or, on request, in individual colours and curved* – for complete design flexibility.

*further information on page 20 – Rail: Creative freedom & installation

Standard colours



white

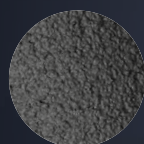

black





EMOTIONAL ACCENTS

The 230 V track Rail makes it possible to create flexible focal points with spotlights, provide ambient lighting with flush-mounted linear inserts or create a cosy ambience with pendant luminaires. The track system follows and accentuates the room concept and architecture with a perfect interplay of direct and indirect lighting. With clear lines and sweeping curves or contrasting geometric figures, Rail brings an interesting dynamic into play.

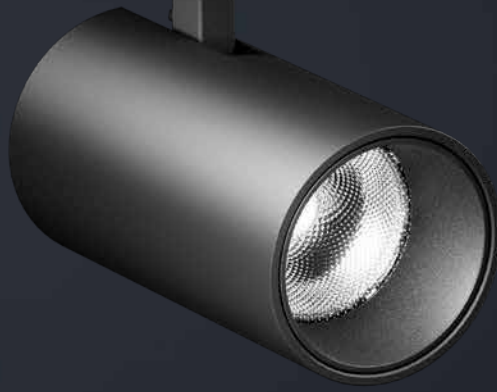

LENTY TRACK AND LENTY MINI

The filigree lens spotlight with Invisible Driver. For point-precise illumination with three different beam angles. Available in two sizes: Lenty Track (Ø 62 mm) and Lenty Mini (Ø 45 mm). Cylindrical housing made of die-cast aluminium in black, white or many other colours on request.



IN.VOLA

Pendant luminaire with Invisible Driver and glass shade in various shapes and colours: as a spherical or conical segment, in white, smoked glass or beige grey.



MUCH MOON

The luminaire sculpture. A decorative pendant luminaire with visible, round light surface. With 155 mm or 240 mm diameter and different suspension lengths. Mounting on the track with the flush-mounted Invisible Driver.

SONNOS

Cylindrical pendant luminaires with diameters 68 mm and 100 mm from the TRILUX Sonnos range. The textile cable is supply line and suspension in one, and mounting to the track is via the Invisible Adapter. Sonnos is available in standard colours black and white and further colours on request.

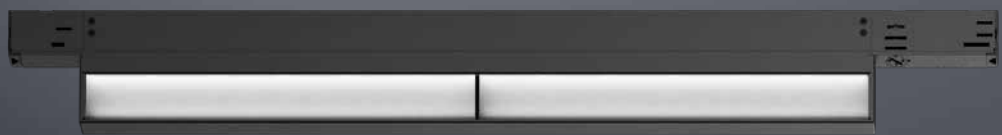

LINELL

Convincing all along the line: Linell, the flush linear inserts for Rail from TRILUX have a special appearance. The luminaires disappear completely into the track – an elegant lighting solution. Linell inserts are available in three lengths: 500 mm, 1,000 mm and 1,500 mm.

With opal optics, Linell inserts create precise lines of light in the space. Thanks to UGR 19, the lens optic fulfils the requirements for standard-compliant lighting in offices. The wallwasher optic is ideal for displaying vertical objects, e.g. pictures on walls or uniformly illuminated wall surfaces.

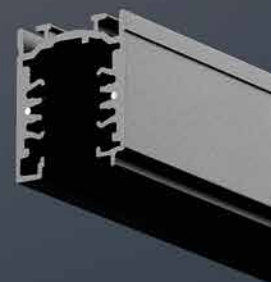

SUSPENDED TRACK

With suspended mounting and indirect light component, Rail provides pleasant ceiling illumination.



FINEA

Linear track luminaires with various lighting technology options. ConVision® technology as UGR 19 variants, alternatively also with opal optic.

LIGHTPANEL CONVISION®

Highly efficient workstation luminaires as a double-row version for higher illuminances. Thanks to UGR 16 or UGR 19, ConVision® optics enable standard-compliant lighting for DSE workstations.

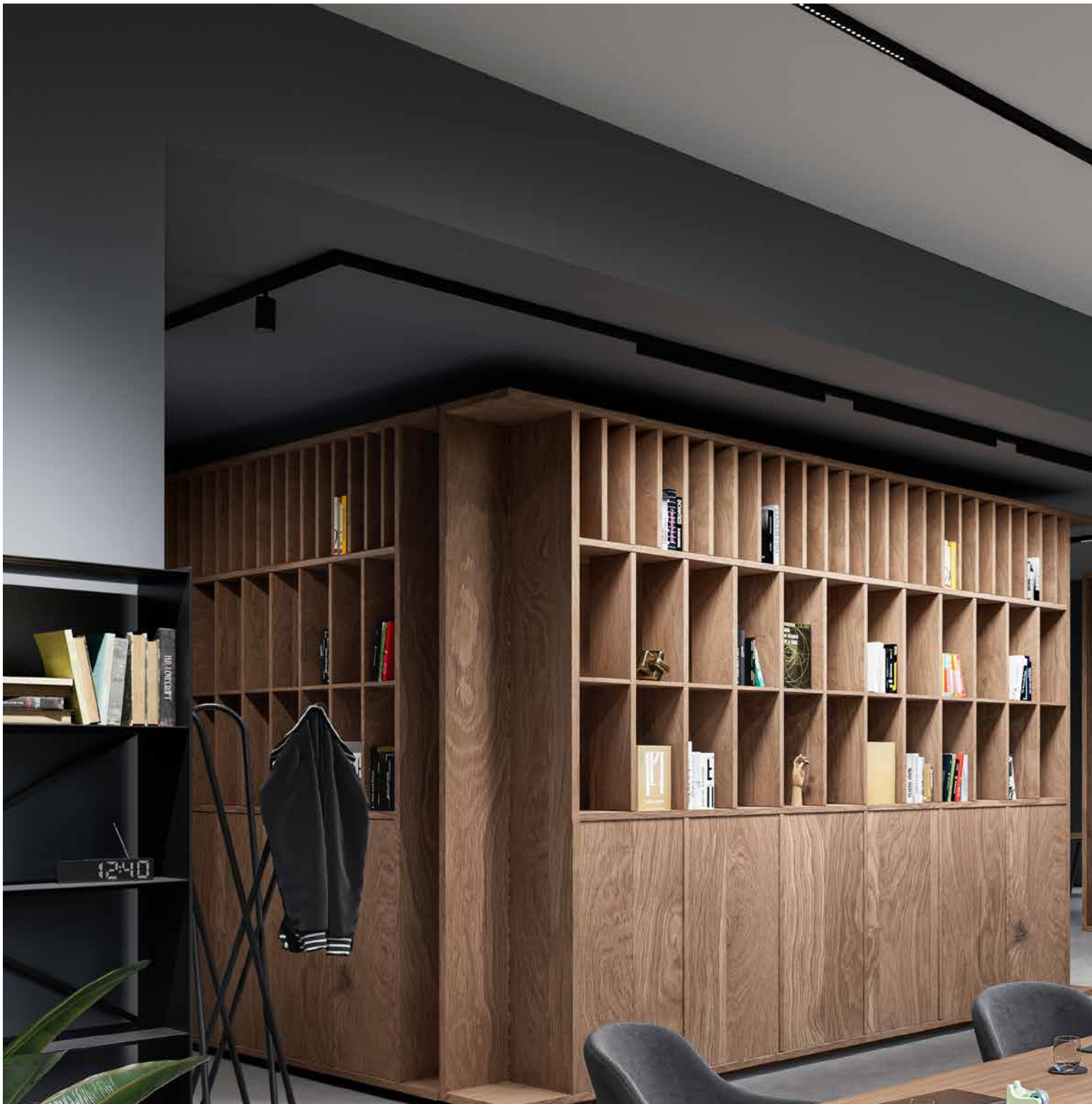

ATTRACTIVE AND ADAPTIVE LIGHTING CONCEPTS

Always the right light: Linell inserts provide pleasant basic lighting, wallwasher illuminate shelves in a uniform way while spotlights and pendant luminaires create high-contrast, atmospheric lighting moods wherever relaxation or informal encounters take centre stage and the room is to be optimally displayed.







SIMPLIFY FROM PLANNING TO OPERATION

● PLANNING

Lines, structures, grids: easy to plan and implement with Rail.
The online planning aid helps select the right connectors and accessories.

● INSTALLATION

Mounting and electrical connection of tracks are extremely straightforward, luminaires are inserted without tools, the adapter fixes and makes contact at the same time.

● OPERATION

The outstanding feature of a track system: its adaptability during operation. If the room layout and usage change, simply move or replace the luminaires – a maximally flexible solution.

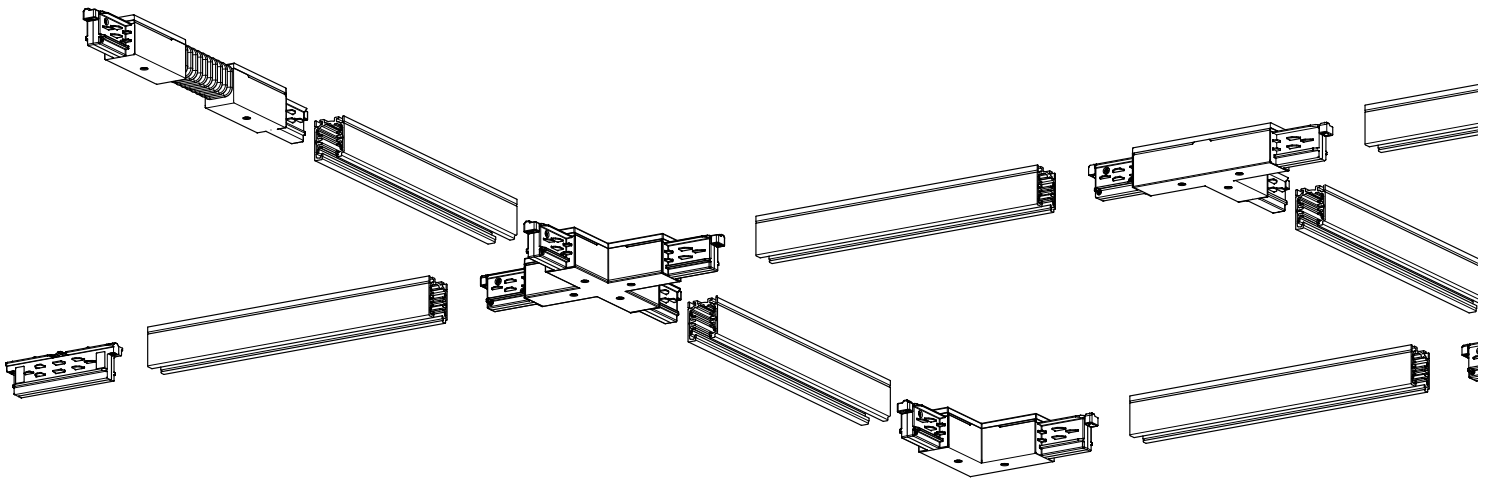

Planning aid online at:
www.trilux.com/rail-planning-aid

PLANNING EXAMPLES

Recessed track

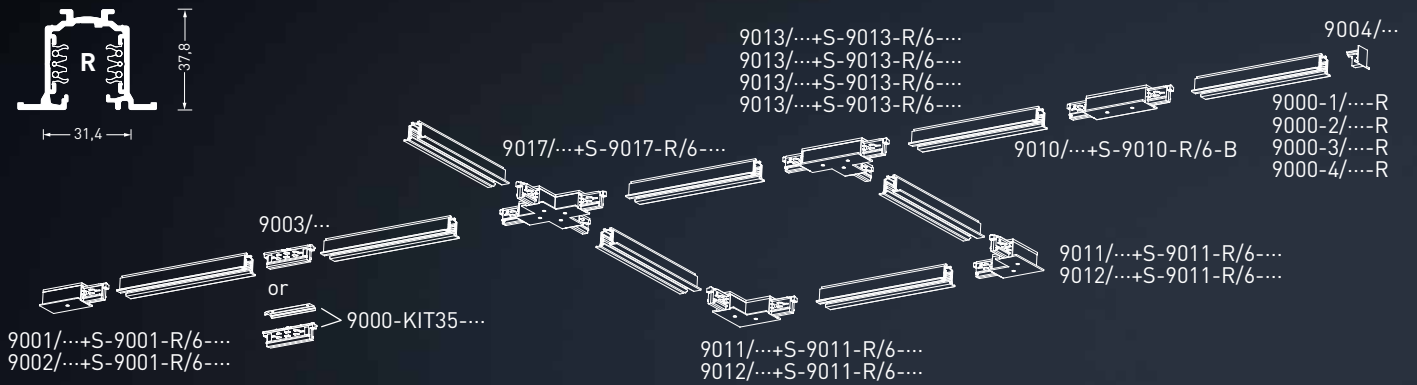

Flush track (trimless)

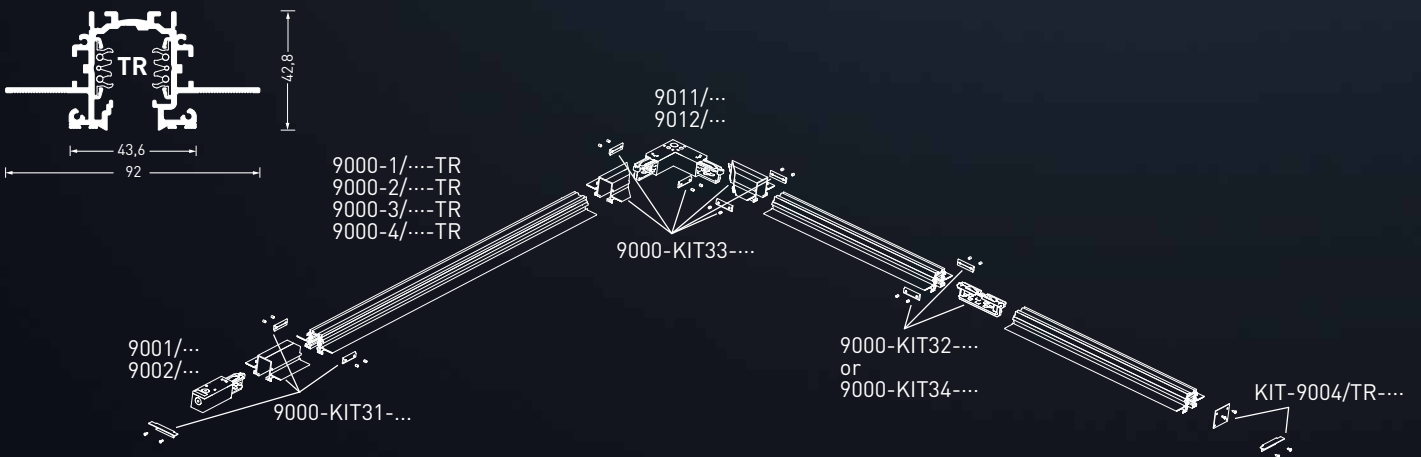

Suspended track with indirect component

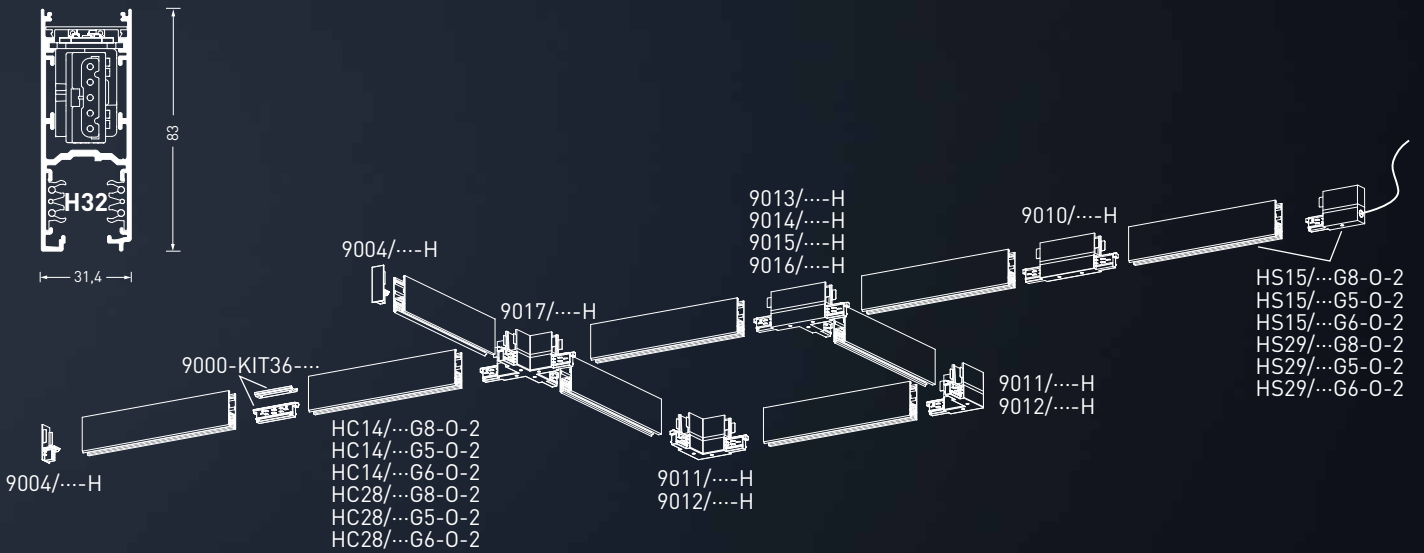

Surface-mounted track (can also be suspended)

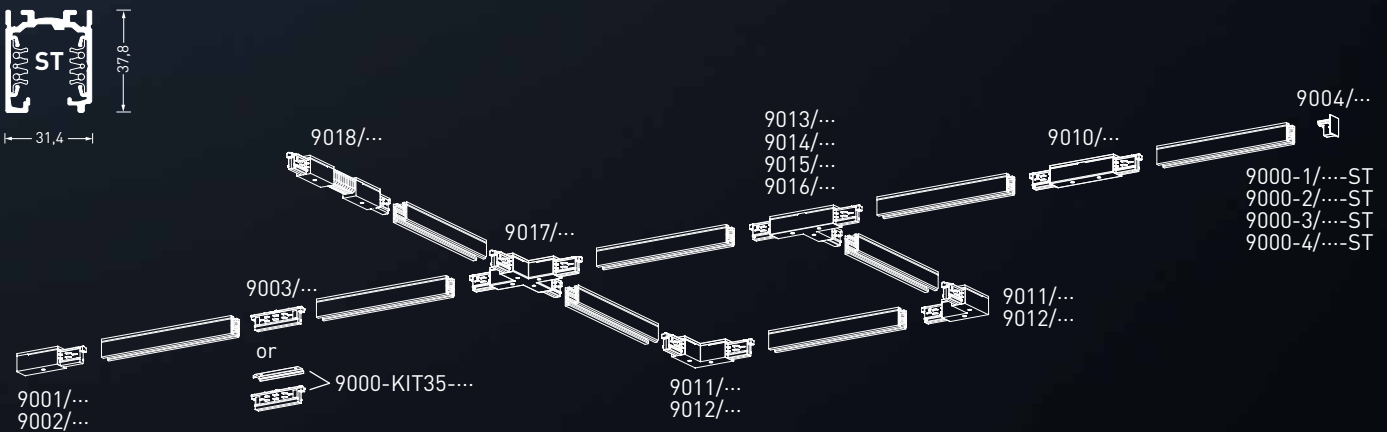





OFFICE LIVING

Office meets living: pendant luminaires create a feel-good atmosphere and an attractive room impression. Spotlights provide exciting accent lighting, while Lightpanel ConVision® inserts provide glare-free, standard-compliant light. Thanks to the flexibility of the track system, the lighting can be modified in next to no time if the room layout changes.

RAIL DESIGN FLEXIBILITY

INDIVIDUAL COLOURS

In addition to the standard black or white, the track is also available in other individual colour variants on request. Accessories such as feeders and connectors cannot be customised.

RAL COLOUR EXAMPLES

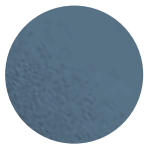

pigeon blue

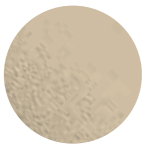

light ivory

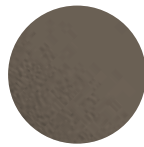

beige grey

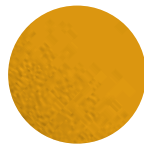

signal
yellow

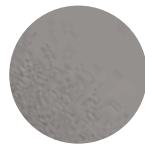

white
aluminium



cobalt blue



moss green

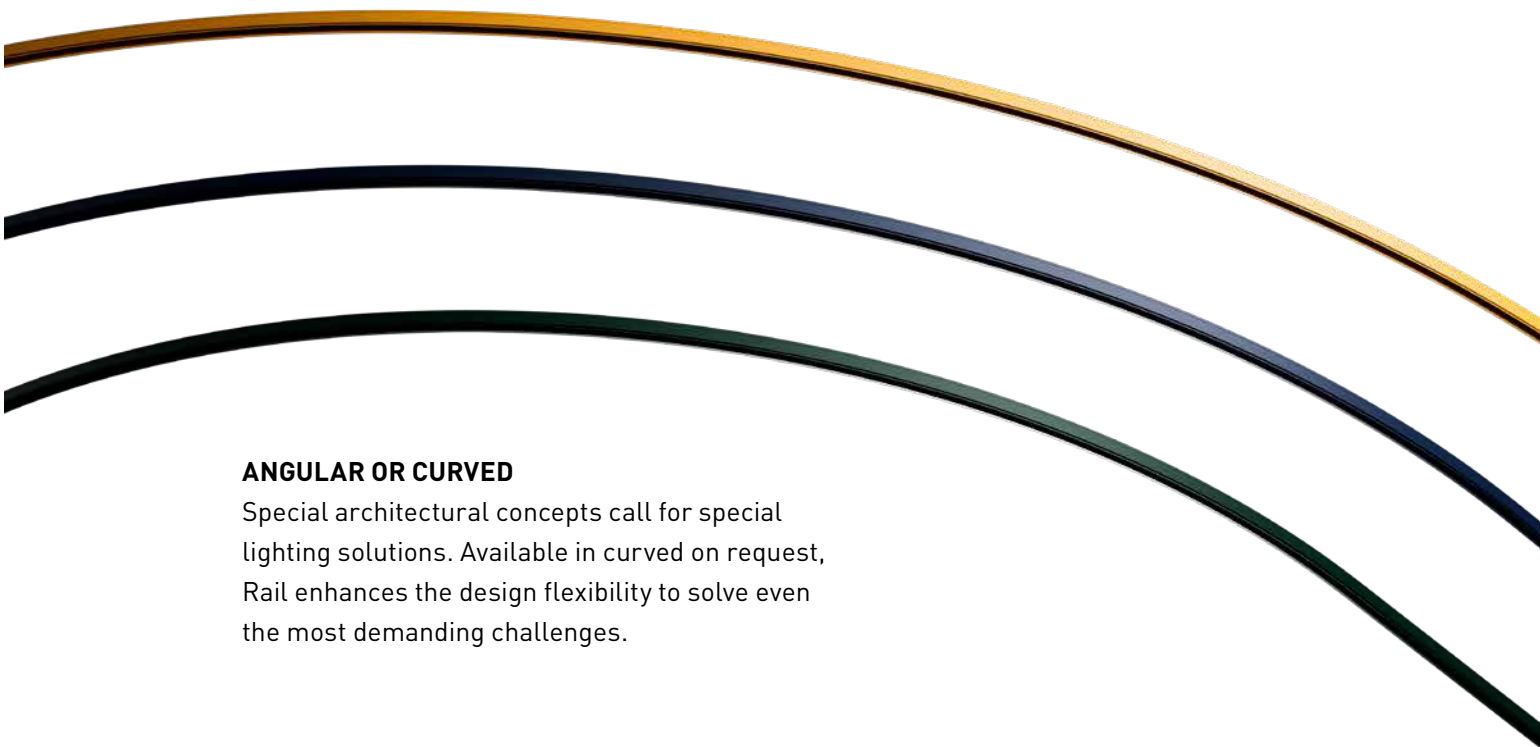
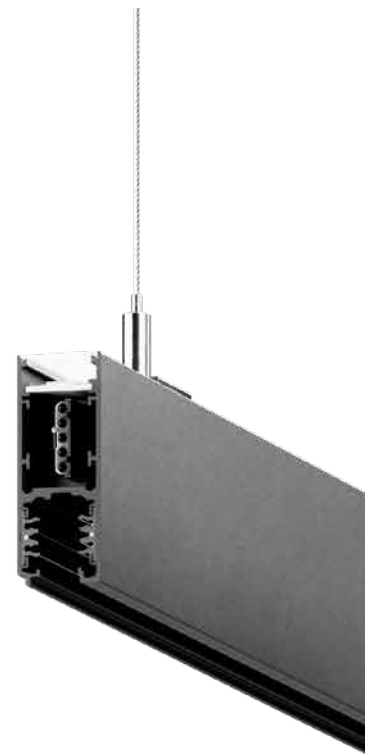

ANGULAR OR CURVED

Special architectural concepts call for special lighting solutions. Available in curved on request, Rail enhances the design flexibility to solve even the most demanding challenges.



RAIL MOUNTING OPTIONS

Numerous mounting options allow complete flexibility and design freedom for various architectural requirements. Whether on walls or ceilings, recessed or plastered into suspended ceilings or suspended with an indirect light component.



ENTRANCE AND RECEPTION AREA

How to create a brilliant reception: with Rail as the basis for spotlights and wallwashers, giving a perfect combination of accenting and vertical illumination.



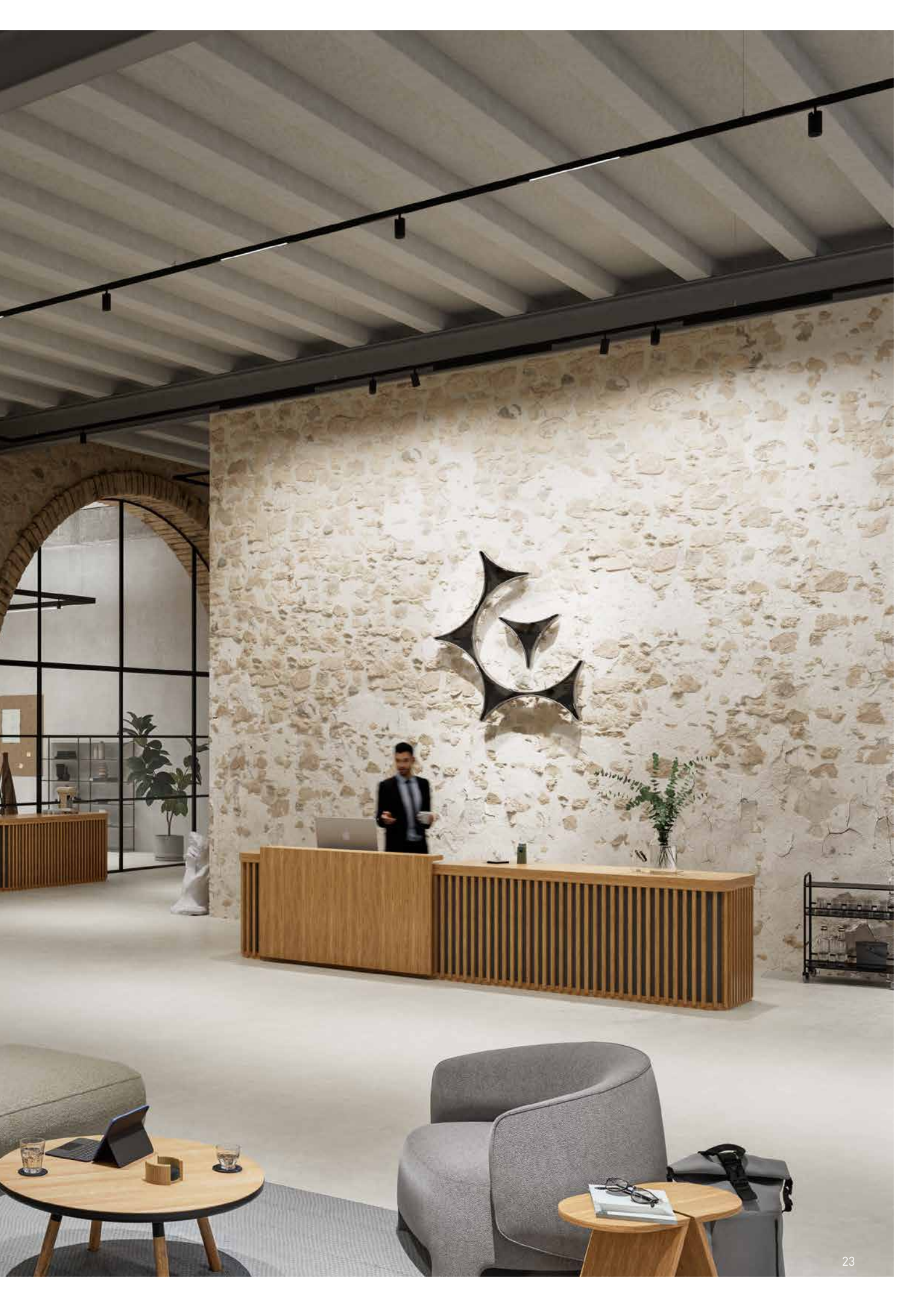

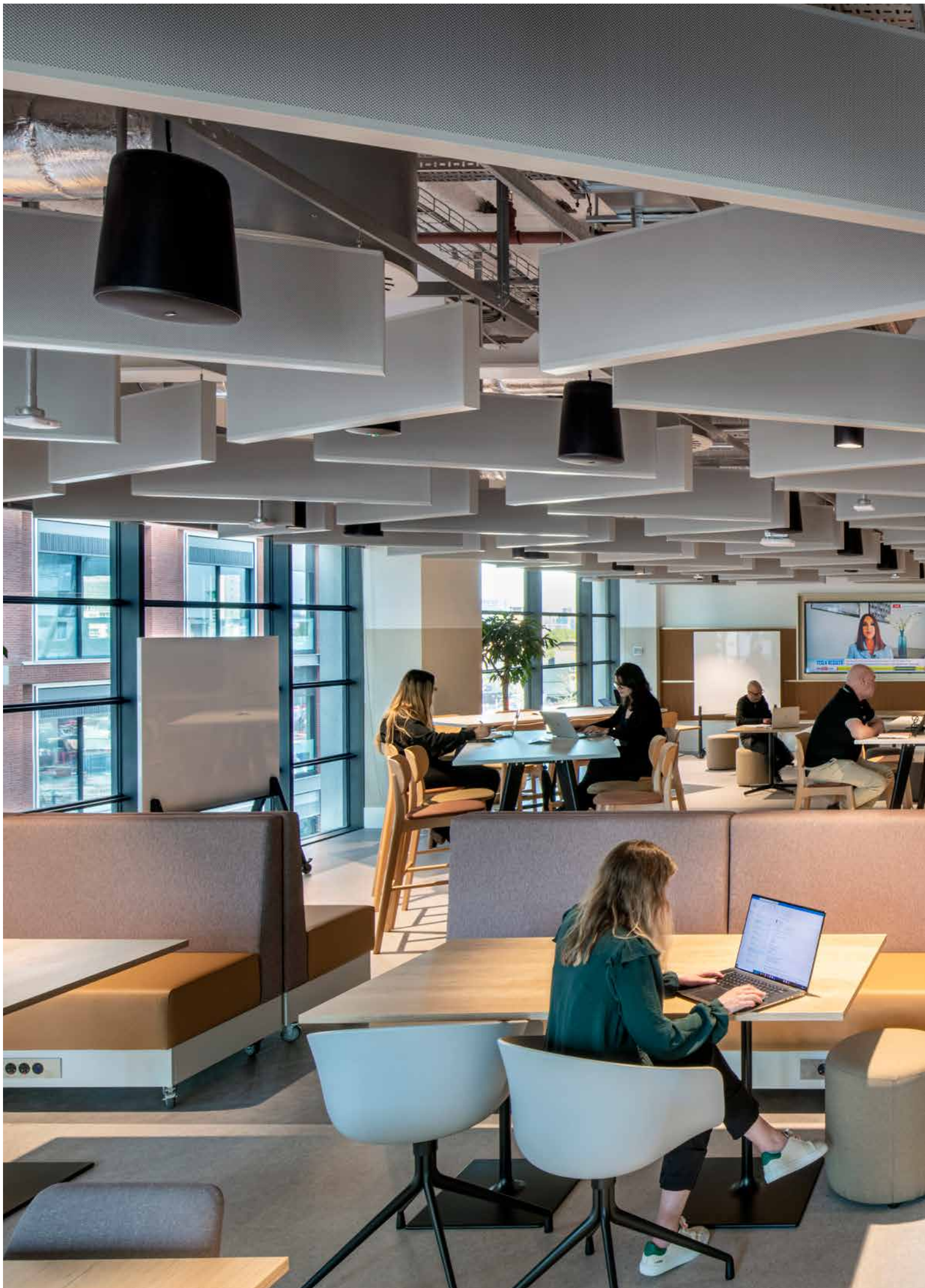

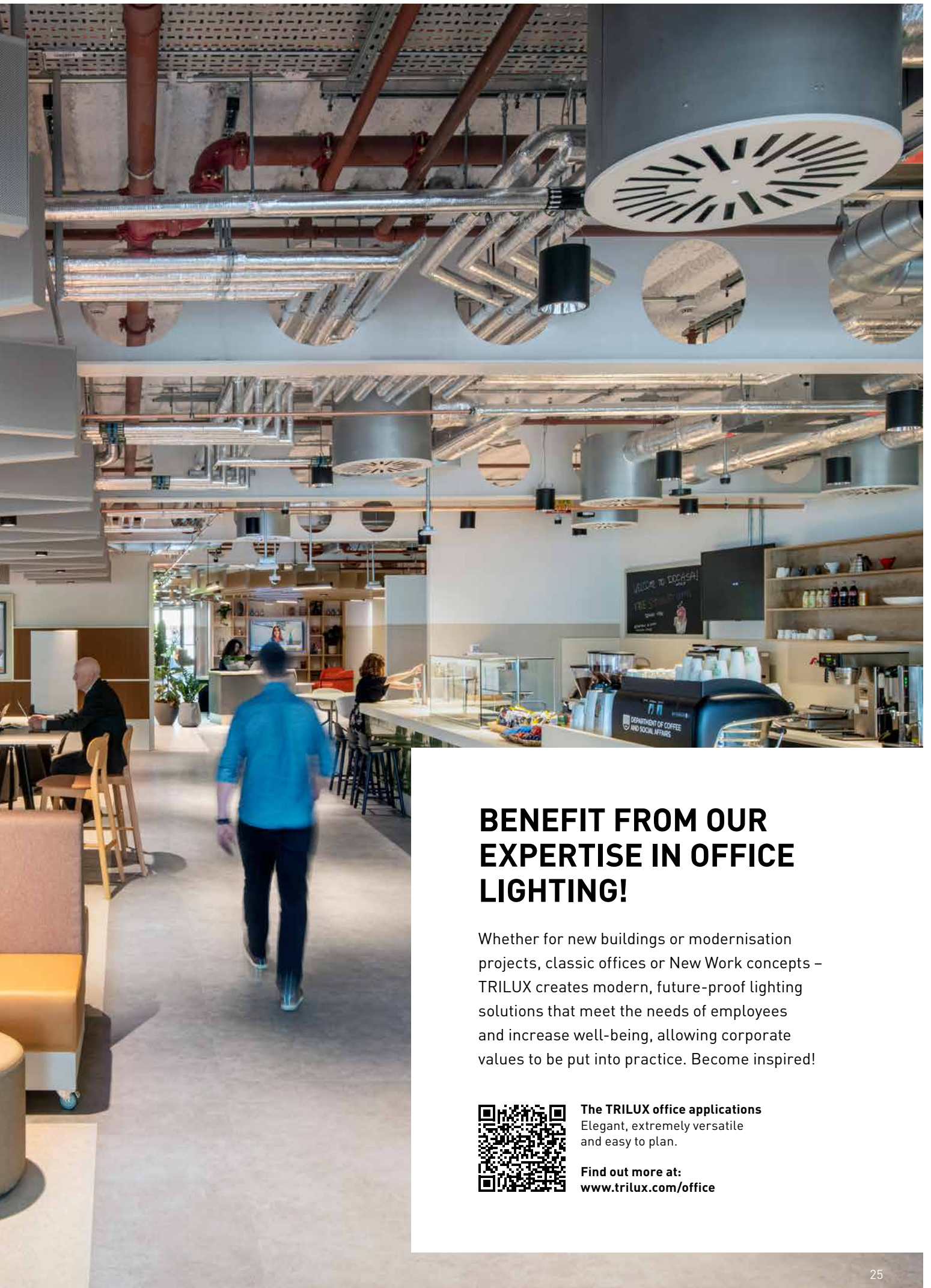

BENEFIT FROM OUR EXPERTISE IN OFFICE LIGHTING!

Whether for new buildings or modernisation projects, classic offices or New Work concepts – TRILUX creates modern, future-proof lighting solutions that meet the needs of employees and increase well-being, allowing corporate values to be put into practice. Become inspired!



The TRILUX office applications
Elegant, extremely versatile
and easy to plan.

Find out more at:
www.trilux.com/office

RAIL

MODULE FEATURES

RAIL - 3-CIRCUIT TRACK (230 V)

 **Mounting method**
Recessed, flush-mounted, surface-mounted, suspended

 **Lengths**
recessed, flush-mounted,
surface-mounted: 1,000 mm, 2,000 mm, 3,000 mm, 4,000 mm
suspended: 1,405/1,500 mm, 2,810/2,905 mm

 **Colours**
White (similar to RAL 9016), black (RAL 9005),
Track available in other RAL colours on request,
accessories such as feeders and connectors not.

 **Electrical version**
ETDD

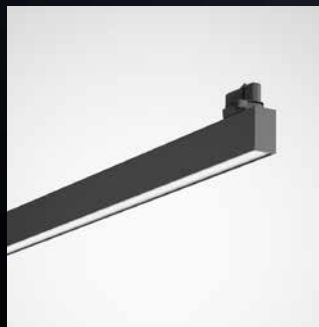

LINELL

 **Mounting method**
3-circuit track, invisible (invi)

 **Light module lengths**
500 mm, 1,000 mm, 1,500 mm

 **Energy efficiency**
up to 130 lm/W with light colour 840

 **Luminous flux**
Opal: 1,100 lm, 2,100 lm, 3,200 lm
Lens: 1,200 lm, 2,200 lm, 3,300 lm
Wallwasher: 1,000 lm, 2,000 lm

 **Service life**
L80 50,000 h

 **Colour temperatures**
2,700 K, 3,000 K, 4,000 K

 **Optics**
Opal, lens, wallwasher

 **Colour rendering**
CRI 80, CRI 90

 **Glare control**
Lens: UGR<19

 **Electrical version**
ETDD

 **Colours**
White (similar to RAL 9016), black (RAL 9005)

FINEA

 **Mounting method**
3-circuit track

 **Lengths/widths**
1,065 mm (further lengths in the configurator)/
35, 50 mm

 **Energy efficiency**
up to 110 lm/W with light colour 840

 **Luminous flux**
Opal: 2,600 lm
Lens: 3,100 lm

 **Service life**
L80 50,000 h

 **Colour temperatures**
3,000 K, 4,000 K

 **Optics**
Opal, lens [ConVision®]

 **Colour rendering**
CRI 80 (CRI 90 via configurator)

 **Glare control**
Opal: UGR<25, lens: UGR<19

 **Electrical version**
ETDD

 **Colours**
White (similar to RAL 9016), black (RAL 9005)





LENTY TRACK

 **Mounting method**
3-circuit track, invisible (invi)

 **Lengths**
Ø 62 mm, L 109 mm (luminaire head)

 **Energy efficiency**
up to 128 lm/W with light colour 840,
up to 110 lm/W with light colour 940

 **Luminous flux**
1,500 lm, 2,000 lm

 **Service life**
L80 50,000 h

 **Colour temperatures**
2,700 K, 3,000 K, Efficient White (EW),
Brilliant Color (BC), 3,500 K, 4,000 K,
Efficient Cool (EC)

 **Optic**
Lens (ConVision®)

 **Beam angles**
Spot 19°, Medium Flood 22°, Flood 32°

 **Colour rendering**
CRI 80, CRI 90

 **Electrical version**
ETDD

 **Colours**
White (similar to RAL 9016), black (RAL 9005)



LENTY MINI

 **Mounting method**
3-circuit track, invisible (invi)

 **Lengths**
Ø 45 mm, L 85 mm (luminaire head)

 **Energy efficiency**
up to 86 lm/W with light colour 840,
up to 74 lm/W with light colour 940

 **Luminous flux**
500 lm, 1,000 lm

 **Service life**
L80 50,000 h

 **Colour temperatures**
2,700 K, 3,000 K, 3,500 K, 4,000 K, Efficient Cool (EC)

 **Optic**
Lens (ConVision®)

 **Beam angles**
Spot 19°, Medium Flood 22°, Flood 32°

 **Colour rendering**
CRI 80, CRI 90

 **Electrical version**
ETDD

 **Colours**
White (similar to RAL 9016), black (RAL 9005)

RAIL MODULE FEATURES



SONNOS PENDANT

- Mounting method**
3-circuit track, invisible (invi)
- Diameters and lengths**
RH1: Ø 64 mm, L: 205 mm; RH3: Ø 96 mm, L: 175 mm,
pendant length variable up to 1,800 mm
- Energy efficiency**
up to 135 lm/W with light colour 840,
up to 115 lm/W with light colour 940
- Luminous flux**
RH1: 500, 800 lm; RH3: 800, 1,400 lm
- Service life**
L90 50,000 h / L80 100,000 h
- Colour temperatures**
2,700 K, 3,000 K, 4,000 K
- Optic**
Lens (ConVision®)
- Beam angles**
Spot 12°, Medium Flood 24°, Flood 36°,
Very wide Flood 60°
- Colour rendering**
CRI 80, CRI 90
- Glare control**
Lens: UGR<19
- Electrical version**
ETDD
- Colours**
Luminaire housing: white (similar to RAL 9016),
black (RAL 9005), silver (RAL 9006)
Limiter: white, black, semi-specular, highly specular
Other colours on request



MUCH MOON

- Mounting method**
3-circuit track, invisible (invi)
- Diameter and lengths**
Ø 165 mm, Ø 240 mm; pendant length variable
from 600 mm to 2,000 mm; on request up to
max. 4,000 mm
- Energy efficiency**
up to 122 lm/W with light colour 840
- Luminous flux**
2,000 lm, 3,000 lm
- Service life**
L80 50,000 h
- Colour temperatures**
3,000 K, 4,000 K
- Optic**
Opal
- Beam angle**
Diffuse (opal)
- Colour rendering**
CRI 80
- Electrical version**
ETDD
- Colours**
White (similar to RAL 9016), black (RAL 9005),
other colours on request



IN.VOLA

-  **Mounting method**
3-circuit track, invisible (invi)

-  **Diameter and lengths**
Ø 163 mm (glass, conical), Ø 222 mm (glass, round), Ø 295 (fabric, conical); pendant lengths: 1,500 mm, 3,000 mm

-  **Energy efficiency**
dependant on light source – max. 60 W

-  **Luminous flux**
dependant on light source – max. 60 W

-  **Service life**
dependant on light source – max. 60 W

-  **Colour temperatures**
dependant on light source – max. 60 W

-  **Beam angle**
dependant on light source – max. 60 W

-  **Colour rendering**
dependant on light source – max. 60 W

-  **Electrical version**
for E27 lamps

-  **Colours**
Luminaire colour: black (RAL 9005); glass: white, smoked glass, beige grey, fabric (various colours)

LIGHTPANEL CONVISION®

-  **Mounting method**
3-circuit track, 1-point mounting, 90°

-  **Length/width/height**
616 mm x 137 mm x 38 mm

-  **Energy efficiency**
up to 155 lm/W with light colour 840

-  **Luminous flux**
4,500 lm, 6,500 lm

-  **Service life**
L80 50,000 h

-  **Colour temperatures**
3,000 K, 4,000 K, Tunable White 2,700-6,500 K

-  **Optic**
Lens (ConVision®)

-  **Beam angles**
Wide, Double-Asymmetric Wide, Asymmetric Narrow

-  **Colour rendering**
CRI 80, CRI 90

-  **Glare control**
UGR<19 (Wide)

-  **Electrical version**
ETDD

-  **Colours**
White (similar to RAL 9016), black (RAL 9005)

CONTACTS

TRILUX GmbH & Co. KG

Heidestraße · D-59759 Arnsberg
Postfach 19 60 · D-59753 Arnsberg
Tel. +49 2932 301-0
sales@trilux.com
www.trilux.com

TRILUX LIGHTING LIMITED

TRILUX HOUSE, Winsford Way
Boreham Interchange
Chelmsford, Essex
CM2 5PD
Tel. +44 1245 463463
info.co.uk@trilux.com
www.trilux.com

All technical data including dimensional and weight specifications have been checked carefully. Errors excepted. Possible colour deviations are due to printing processes. We reserve the right to modify in the interest of progress. Luminaires are partly shown with accessories that must be ordered separately. Images of installations may show custom manufactured luminaires. Printed on PEFC-certified paper in an environmentally friendly way.

