

**TRILUX**  
SIMPLIFY YOUR LIGHT.

DATA CENTRE  
LIGHTING

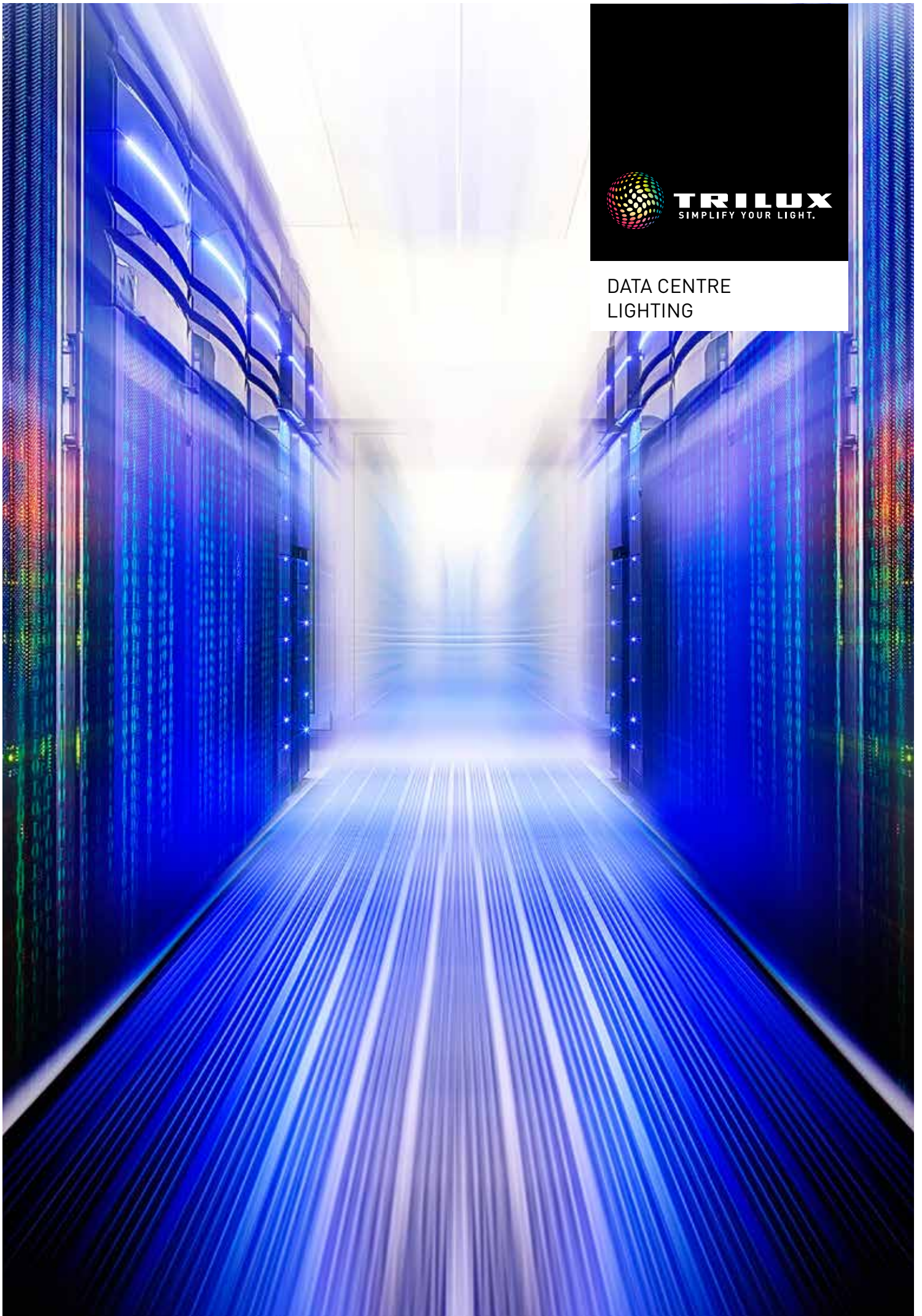



**DATA CENTRES**

Overview	Page 4
Data halls	Page 6
Lighting application	Page 8



**E-Line Next**

Key features	Page 10
Options	Page 12
System overview	Page 13



**Light management system**

LiveLink Standard	Page 14
LiveLink Premium	Page 16



**Applications**

Control rooms	Page 18
Plant rooms	Page 20
Entrance area	Page 22
Offices	Page 24
Security rooms	Page 26
Corridors	Page 28
Stairs	Page 30
Canteens	Page 32
Sanitary facilities	Page 34
Outdoor	Page 36
Light around the building	Page 38



**Emergency Lighting**

Escape routes and anti-panic areas	Page 40
BLFs and high temperature lithium batteries	Page 42
Central battery system	Page 44



**TRILUX Lighting and services**

Key facts	Page 46
TRILUX Quality	Page 47
Lighting design	Page 48
Sustainability	Page 49
Financing	Page 50

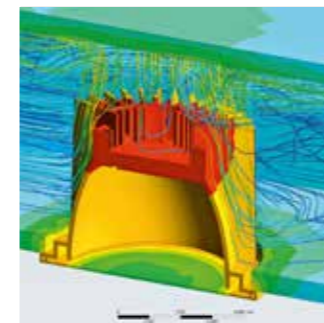

**Technology**

Optical design	Page 52
Binning	Page 53
LED lifetime and thermal design	Page 54

# DATA CENTRES

THE RIGHT SOLUTION FOR EVERY APPLICATION

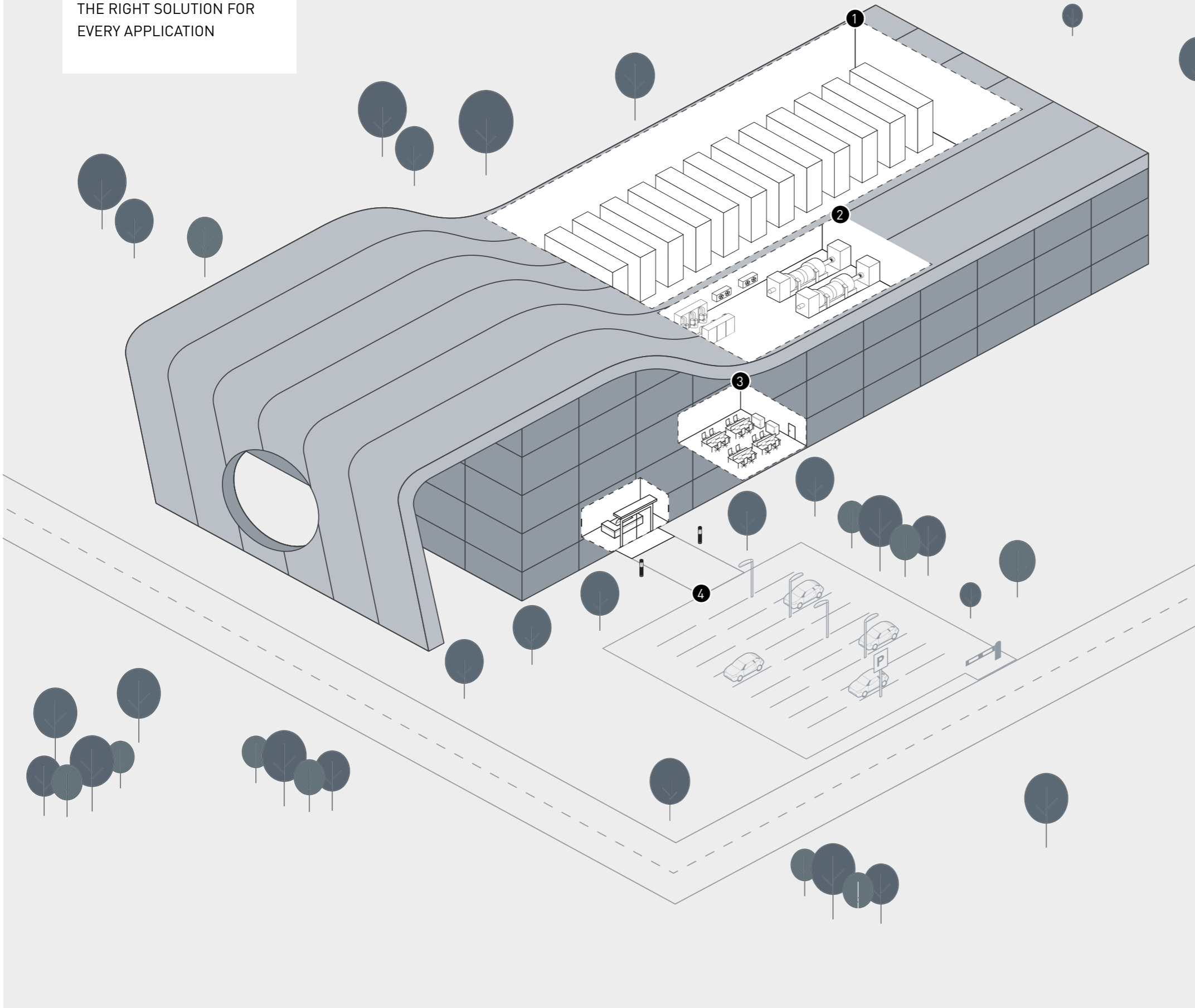

**1** Data halls



**2** Plant rooms



**3** Control rooms & offices



**4** Outdoor



## DATA HALLS

### RECOMMENDED LUMINAIRES

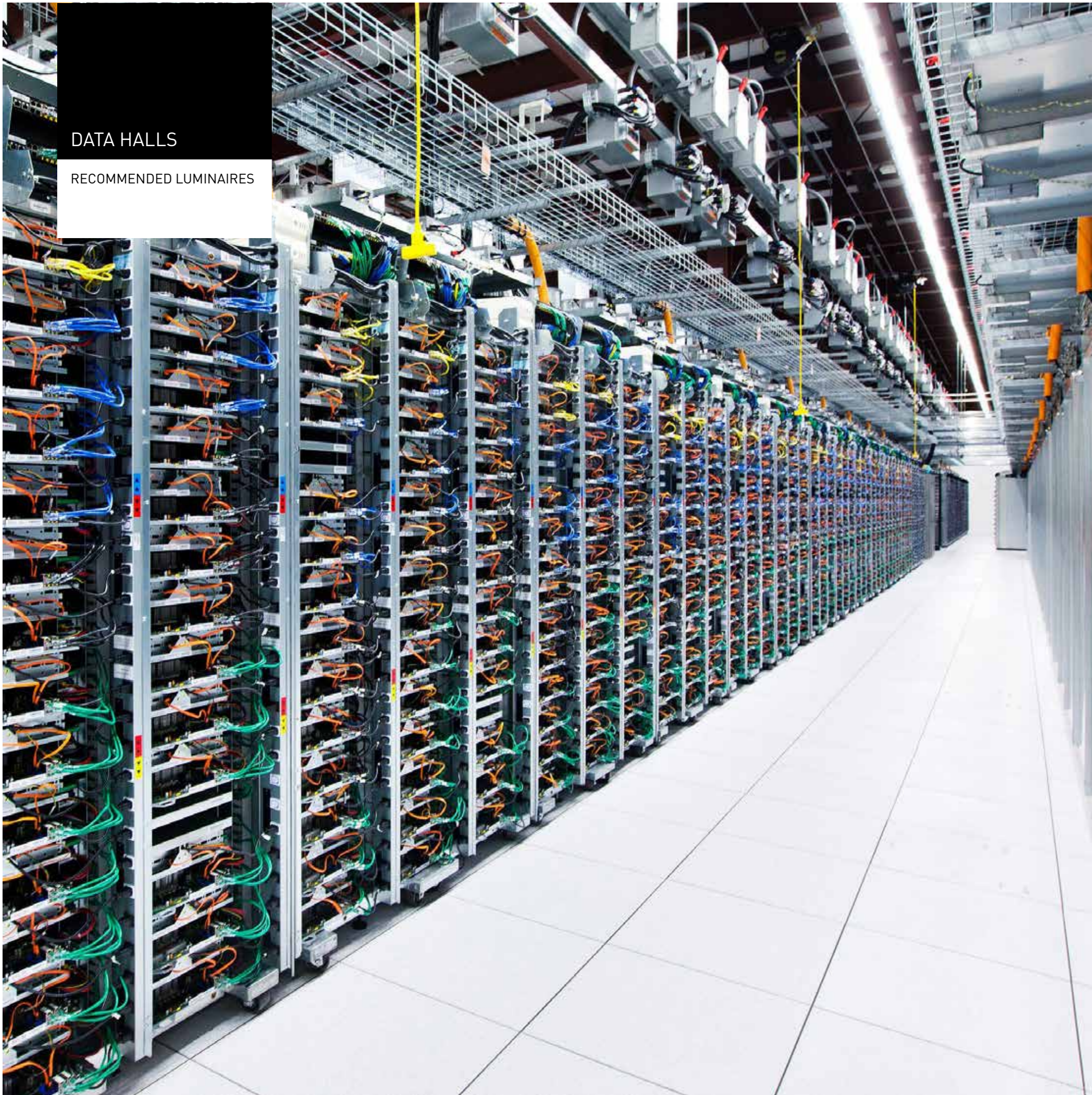

TRILUX products can offer high-end efficiency of 190lm/W. This level of efficiency means more than a mere saving on the power consumption of the lighting, this also means that very little heat is generated by the luminaires. For the reliable operation of the servers thermal management is crucial and this will help you to achieve your goal. This also means significantly more efficient HVAC operation saving on the running cost. The efficient operation potentially can save on the cost of the HVAC equipments as well. TRILUX provides a wide range of optical distributions, luminous flux and accessories, these can be combined in the most flexible way to make sure the lighting system meets your project-specific requirements.

**E-Line NEXT FIX**



**E-Line NEXT FLEX**



# LIGHTING APPLICATION EXAMPLES

	Luminaire	Arrangement	Energy consumption per aisle	Server aisle illumination
<b>Option A</b>	E-Line Next HE LW19 50-840 L225	2250mm continuous	351 W	523 lx
<b>Option B</b>	E-Line Next HE LW 40 840 L225	2250mm continuous	280 W	333 lx
<b>Option C</b>	E-Line Next HE LW19 45-840 L225	2250mm lum. - 1000mm blank	219 W	330 lx
<b>Option D</b>	E-Line Next HE LW19 70-840 L225	2250mm lum. - 1000mm blank	340 W	513 lx
<b>Option E</b>	E-Line Next HE LW19 40-840 L150	1500mm lum. - 1500mm blank	216 W	323 lx
<b>Option F</b>	E-Line Next HE LW19 65-840 L150	1500mm lum. - 1500mm blank	351 W	525 lx
<b>Option G</b>	E-Line Next HE LW 80 840 L150	1500mm lum. - 1500mm blank	432 W	516 lx

## Illumination

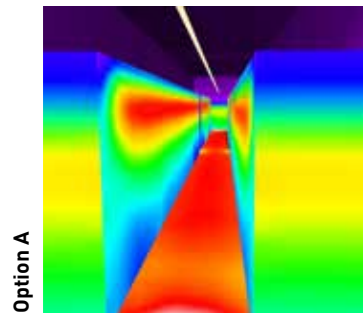

<b>Optics</b>	LW19 - UGR 19
<b>Luminous flux</b>	5000 lm
<b>Mounting height</b>	2,7 m
<b>Number of luminaires</b>	13
<b>Energy consumption</b>	351 W

Server aisle illumination	523 lx
Server aisle uniformity	0,9
Server vertical surface illumination	348 lx
Server vertical surface uniformity	0,5

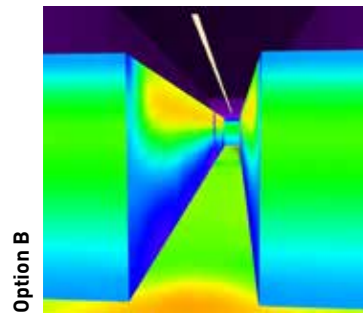

<b>Optics</b>	LW - Wide optics
<b>Luminous flux</b>	4000 lm
<b>Mounting height</b>	2,7 m
<b>Number of luminaires</b>	13
<b>Energy consumption</b>	280 W

Server aisle illumination	333 lx
Server aisle uniformity	0,9
Server vertical surface illumination	268 lx
Server vertical surface uniformity	0,5

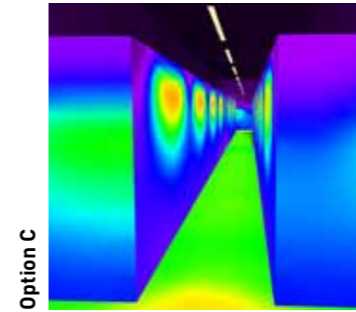

<b>Optics</b>	LW19 - UGR19
<b>Luminous flux</b>	4500 lm
<b>Mounting height</b>	2,7 m
<b>Number of luminaires</b>	9
<b>Energy consumption</b>	219 W

Server aisle illumination	330 lx
Server aisle uniformity	0,9
Server vertical surface illumination	216 lx
Server vertical surface uniformity	0,26

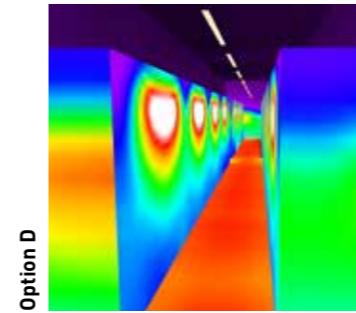

<b>Optics</b>	LW19 - UGR19
<b>Luminous flux</b>	7000 lm
<b>Mounting height</b>	2,7 m
<b>Number of luminaires</b>	9
<b>Energy consumption</b>	340 W

Server aisle illumination	513 lx
Server aisle uniformity	0,9
Server vertical surface illumination	335 lx
Server vertical surface uniformity	0,26

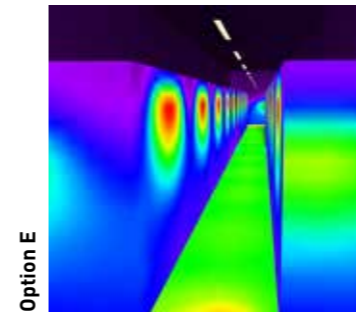
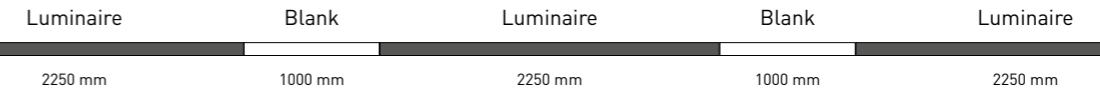

<b>Optics</b>	LW19 - UGR19
<b>Luminous flux</b>	4000 lm
<b>Mounting height</b>	2,7 m
<b>Number of luminaires</b>	10
<b>Energy consumption</b>	216 W

Server aisle illumination	323 lx
Server aisle uniformity	0,9
Server vertical surface illumination	57 lx
Server vertical surface uniformity	0,26

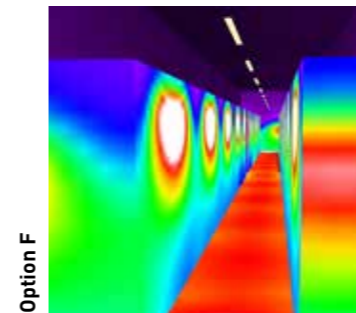

<b>Optics</b>	LW19 - UGR19
<b>Luminous flux</b>	6500 lm
<b>Mounting height</b>	2,7 m
<b>Number of luminaires</b>	10
<b>Energy consumption</b>	351 W

Server aisle illumination	525 lx
Server aisle uniformity	0,9
Server vertical surface illumination	356 lx
Server vertical surface uniformity	0,26

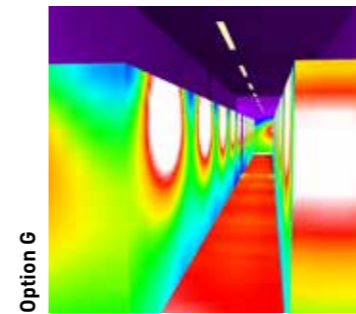

<b>Optics</b>	LW - Wide optics
<b>Luminous flux</b>	8000 lm
<b>Mounting height</b>	2,7 m
<b>Number of luminaires</b>	10
<b>Energy consumption</b>	432 W

Server aisle illumination	516 lx
Server aisle uniformity	0,9
Server vertical surface illumination	419 lx
Server vertical surface uniformity	0,5

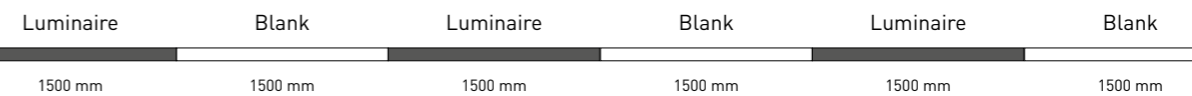

## E-LINE NEXT LED SYSTEM



### Unmatched efficiency



# 190 lm/W

Also means less heat dissipation which results saving on HVAC energy and servicing. Helps to maintain optimal temperature for servers.

### Superior optics



Only with precise light control the advantage of LEDs can be fully used. Superior optics allow to achieve extreme high performance system efficiency of 190 lm/w but most importantly the state-of-the-art optical design provides high-quality glare-free lighting where it is needed. The wide range of 15 available optics covers the need of any possible application.

### Reliability

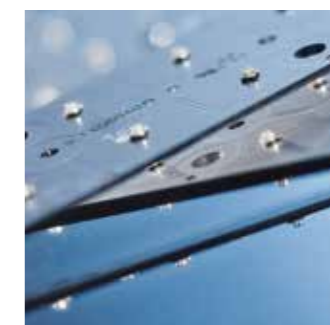

For mission critical applications it is crucial that the lighting is on par with the rest of the system. E-line Next offers extreme lifetime and reliability. We also provide five-year guarantee as proof of quality and safety. Even longer guarantees are available on project basis. The E-Line Next LED HE+ is capable to provide this reliability even in such extreme temperatures as:  
**-25 °C to 50 °C**

### Maximum flexibility

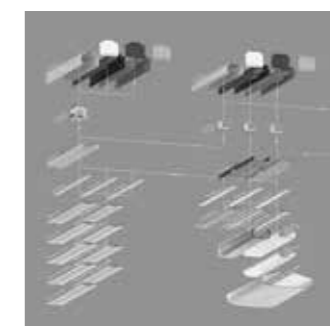

More than 230.000 possible combinations of trunkings and gear trays satisfy the need of any application. Should the application need any special solution beyond these our manufacturing facility in Germany is prepared to develop a tailor-made solution according to the specific customer requirements.

# E-LINE NEXT SYSTEM



## Perfect light and maximum efficiency: the ideal lumen package

Precise selection of the luminous flux guarantees maximum visual comfort and efficiency. This is the reason why the luminous flux packages of E-Line Next LED can be selected from 2,000 to 10,000 lumens in steps of 500. Between 10,000 and 20,000 lumens, the luminous flux packages can be configured in steps of 1,000 lumens.

2000 lm » 2500 lm » 3000 lm » 3500 lm » 4000 lm » 4500 lm » 5000 lm » 5500 lm » 6000 lm » ..... » 10000lm  
 11000 lm » 12000 lm » 13000 lm » 14000 lm » 15000 lm » 16000 lm » 17000 lm » 18000 lm » 19000 lm » 20000lm

With the E-Line NEXT system engineers and architects can have a large number of variants and configurations to match their needs.

<b>3</b>	<b>Trunking types</b>	
<b>3</b>	<b>Colours</b>	
<b>3</b>	<b>Protection ratings</b>	
<b>2</b>	<b>Installation methods</b>	
<b>3</b>	<b>Luminaire insert lengths</b>	
<b>3</b>	<b>Service life classes</b>	
<b>15</b>	<b>Light distributions</b>	
<b>37</b>	<b>Lumen packages</b>	
<b>4</b>	<b>Colour temperature</b>	
<b>2</b>	<b>Colour renderings</b>	
<b>2</b>	<b>Switching types</b>	
<b>9</b>	<b>Additional modules</b>	

# LIVELINK

SIMPLE PLANNING  
RAPID INSTALLATION  
INTUITIVE OPERATION

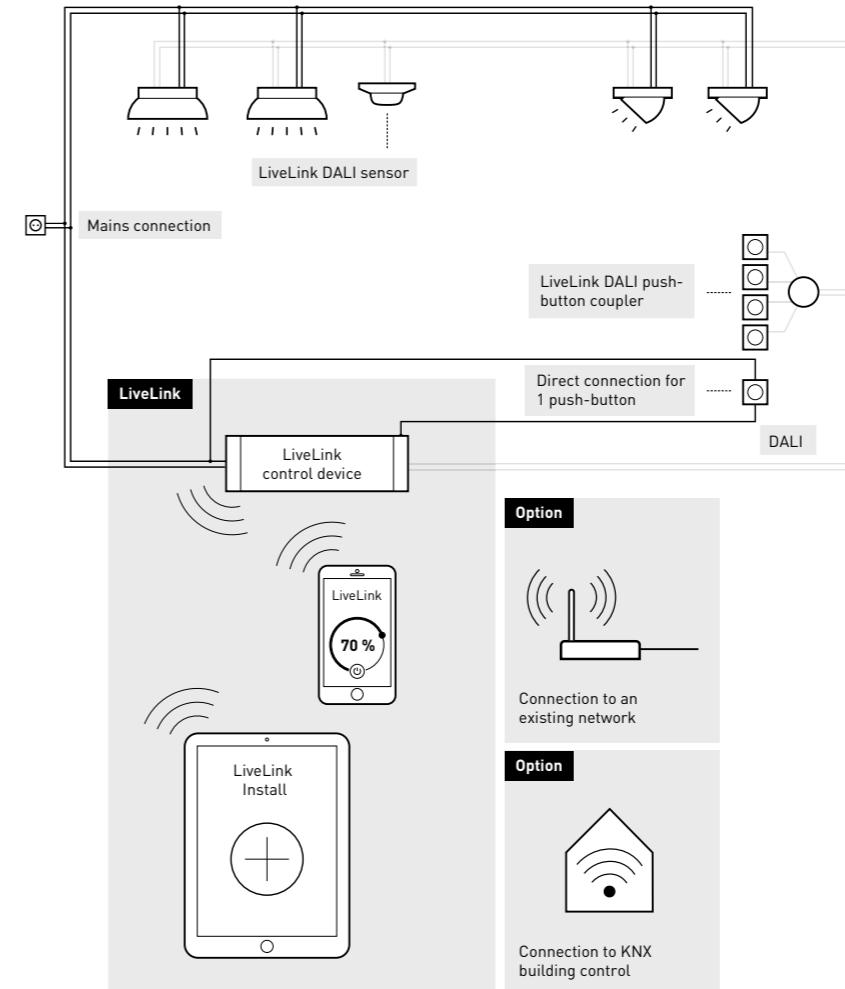

LiveLink was developed to decisively simplify the complex processes of designing, installing, commissioning and operating a light management system. The aim was to gain maximum performance and flexibility along with minimum effort for all participants, ranging from designers to users. LiveLink has achieved these targets at all levels. The high-performance light management system provides simple access to a new world of light and light control.

### Designing: easier than ever before

LiveLink offers a wide selection of preset room configurations for typical applications. These so-called use cases have been designed among other applications for schools, offices and industrial halls and can be individually modified for more complex requirements.

### Installation: simple and quick

LiveLink is rapidly installed thanks to simple wiring: only the mains connection and DALI control lines are needed to interconnect the luminaires and establish a connection to the control system.

### Commissioning: intuitive and mobile using tablets

Commissioning is easy with an iOS or Android tablet and users are guided through the process step-by-step. No extensive prior knowledge is necessary thanks to the intuitive graphic user interface. Especially practical is that correct commissioning can be controlled via visual feedback from the system.

### Operation: conveniently via push-button and app

Many processes such as presence detection and recording daylight levels are carried out automatically by LiveLink with the corresponding configuration. LiveLink can also be controlled conveniently using commercially available push-buttons on walls, or with a simple and high-performance app installed on mobile end devices. System parameters can also be quickly and simply modified with the app.



**LIVELINK PREMIUM**

THE RIGHT SOLUTION FOR EVERY APPLICATION

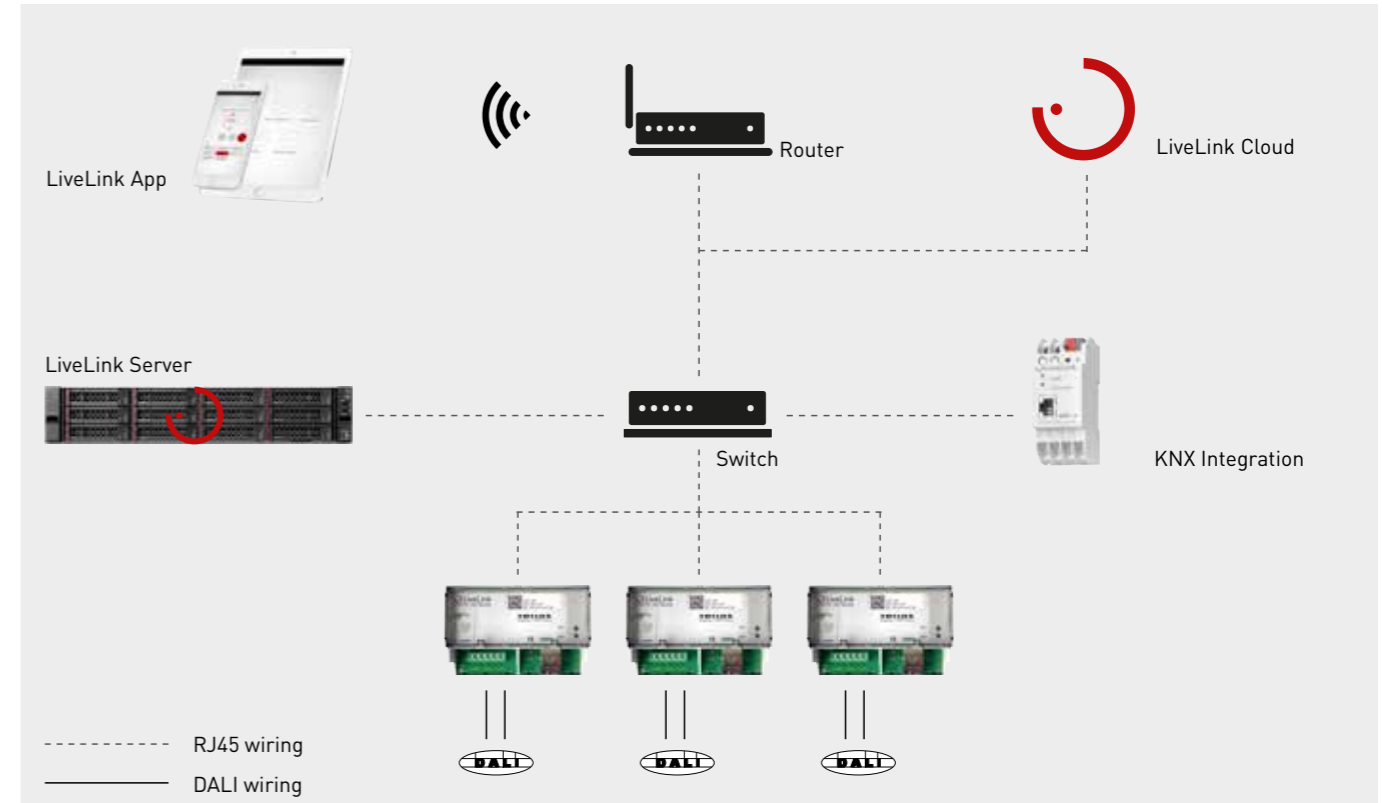

**Live light monitoring - full control of the complete lighting system**

Access to all relevant operating data of the lighting system, in particular active information on necessary maintenance (predictive maintenance).

Clear customer benefits:

- Energy consumption levels are optimized
- Maintenance cycles are adapted to real needs.
- Reduced complexity and cost savings via predictive maintenance instead of fixed maintenance intervals
- New service offer: Generation of added value by installers and facility managers.

Light monitoring supplies data on:

- Operating and dimming status
- Energy consumption and operating duration
- Required (predictive) maintenance
- Error notifications and ECG temperature

**Live energy monitoring**

Analysing & Optimising energy consumption; Energy consumption operating data can be read out via the LiveLink light management system.

Benefits for the customer:

- Higher cost transparency
- Optimisation of energy consumption

Energy monitoring supplies data for:

- Operating status (on or off)
- Energy consumption
- Operating duration /Remaining lifetime



KNX connection

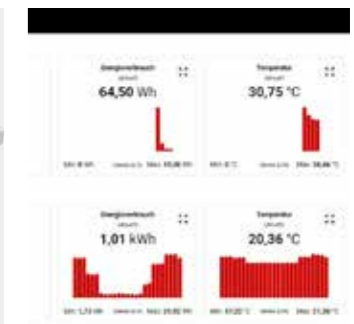

Energy Monitoring

# CONTROL ROOM

## RECOMMENDED LUMINAIRES

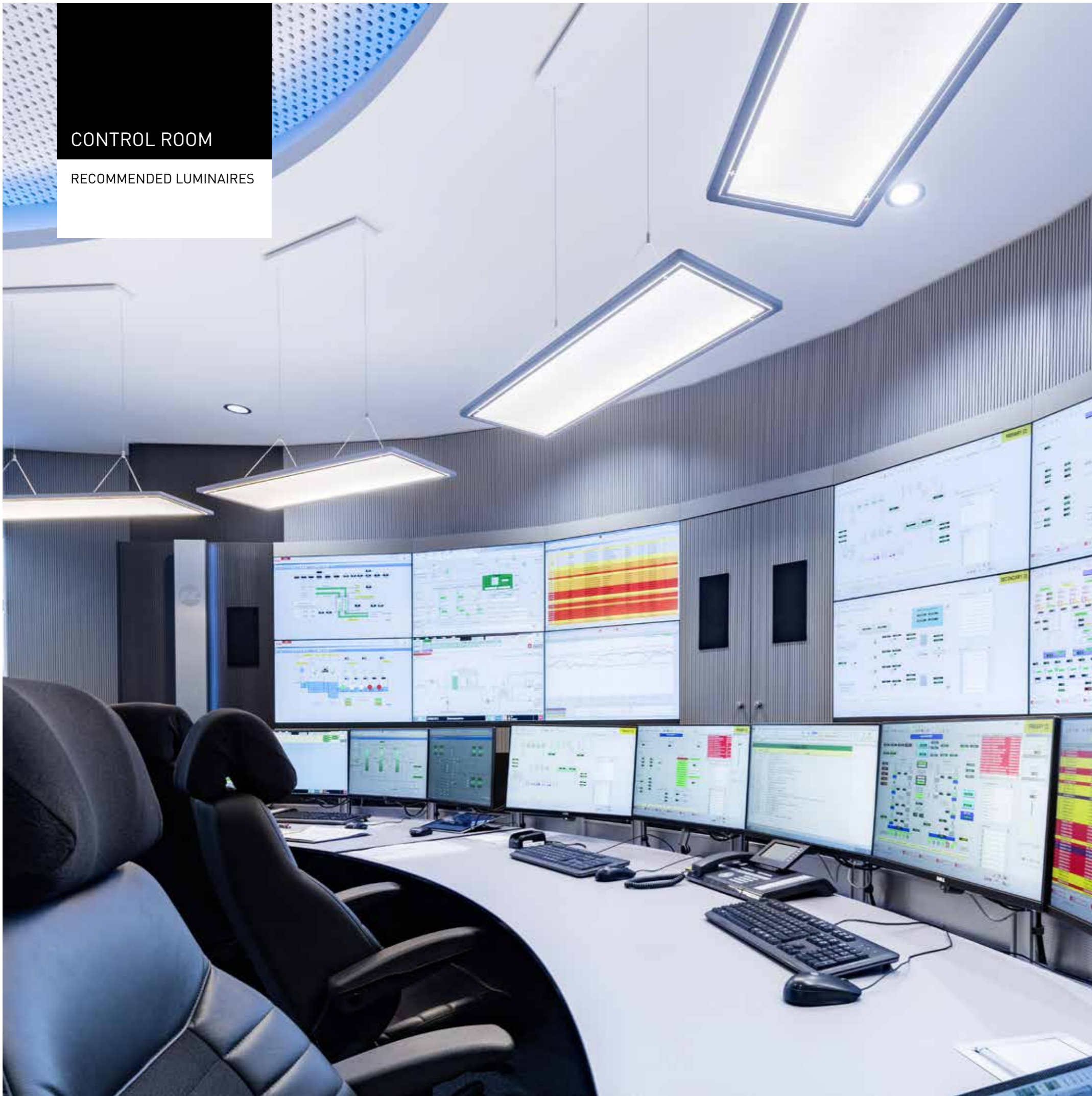

### Lateralo Plus

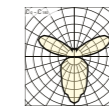

Mounting  
Luminous flux  
L. efficacy  
UGR  
Special feature

suspended  
6400-9600 lm  
126 lm/W  
<19  
transparent glass

### Lunexo

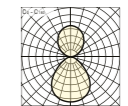

Mounting  
Luminous flux  
L. efficacy  
UGR  
Emergency

suspended  
6600-9000 lm  
111 lm/W  
<19  
Yes

### ArimoFit

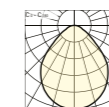

Mounting  
Luminous flux  
L. efficacy  
UGR  
Emergency

recessed  
3000-5200 lm  
136 lm/W  
<19  
Yes

### Sonnos

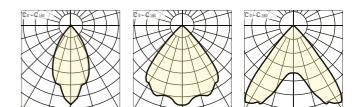

Mounting  
Luminous flux  
L. efficacy  
UGR  
Emergency

recessed  
1000-4000 lm  
130 lm/W  
<19  
Yes

# PLANT ROOMS

## RECOMMENDED LUMINAIRES

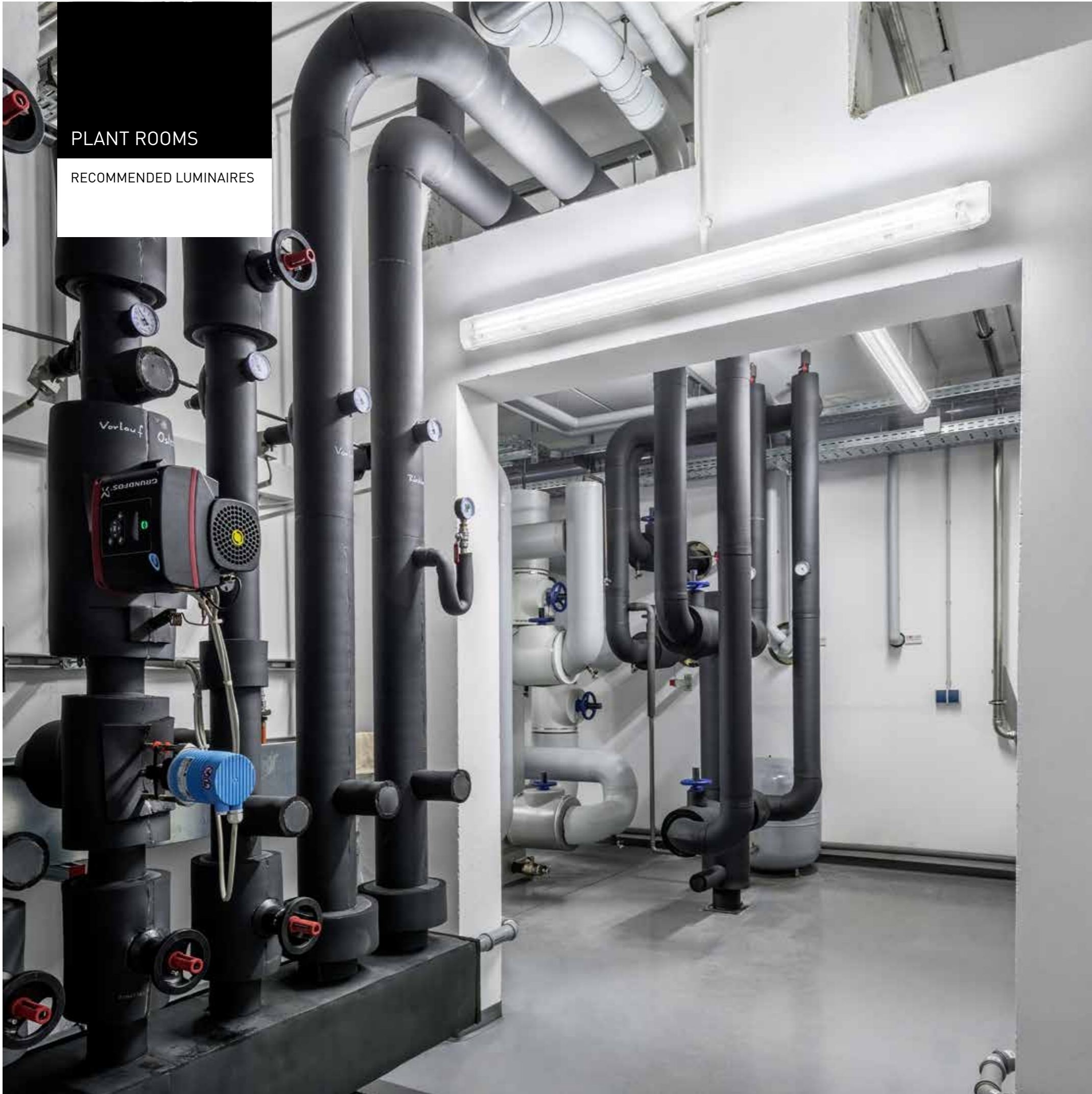

### AragonFit

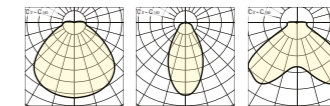

Mounting surface  
Luminous flux 2300 - 8000 lm  
L. efficacy 173 lm/W  
Protection IP66  
Emergency Yes - integral

### Nextrema

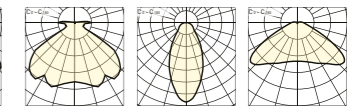

Mounting surface  
Luminous flux 4000 - 8200 lm  
L. efficacy 166 lm/W  
Protection IP66  
Emergency 400lm version

### Duroxo (Gas proof)

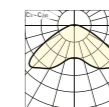

Mounting surface  
Luminous flux 6700 lm  
L. efficacy 148 lm/W  
Protection IP69K  
Emergency No

### Acquex (Explosion proof)

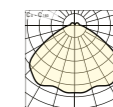

Mounting surface  
Luminous flux 4200 - 5200 lm  
L. efficacy 116 lm/W  
Protection IP66  
Emergency Yes - integral

ENTRANCE LOBBY

RECOMMENDED LUMINAIRES

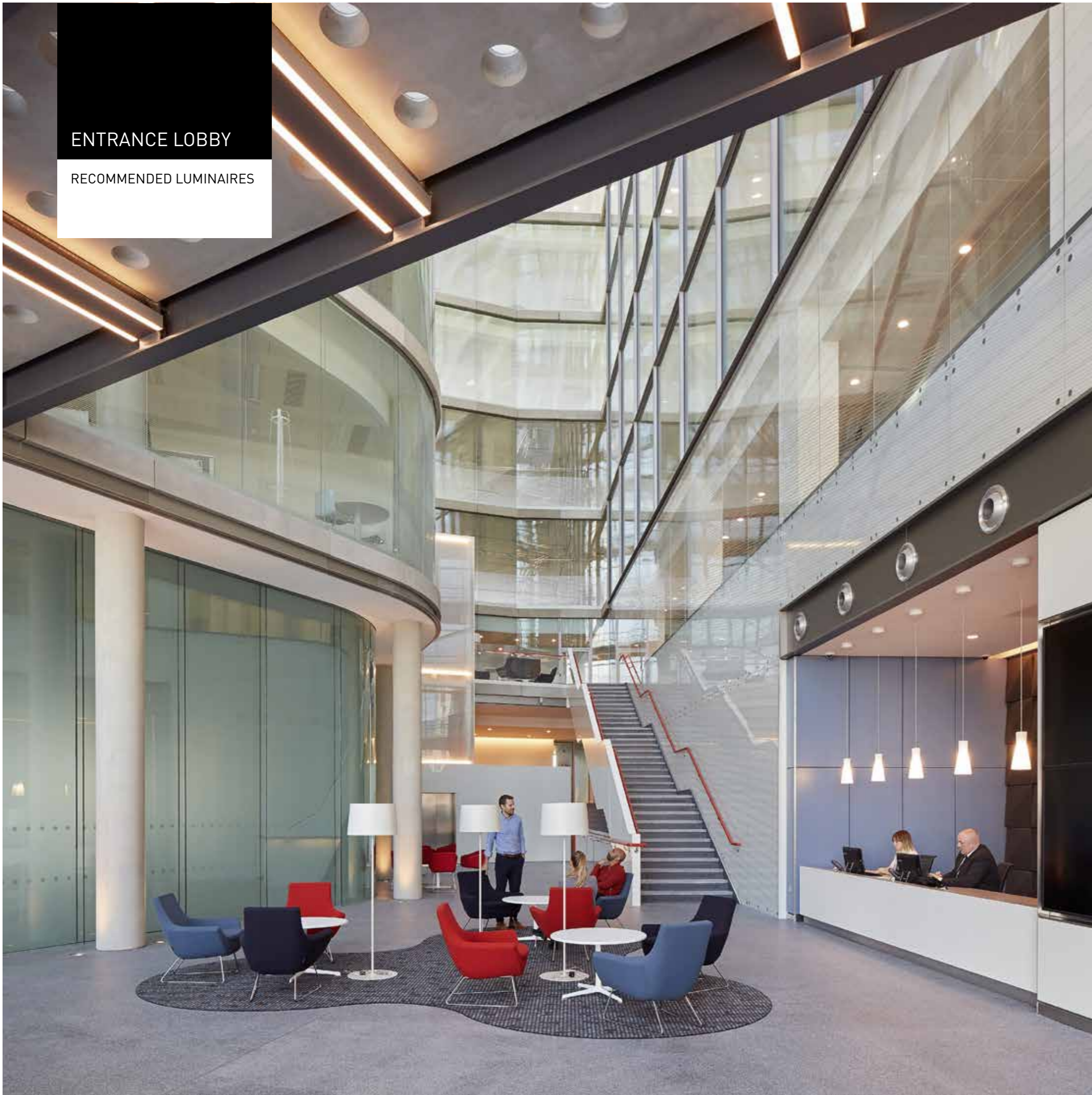

Circle



Onplana H



Sonnos



LateraloR



Solegra



# OFFICES

## RECOMMENDED LUMINAIRES

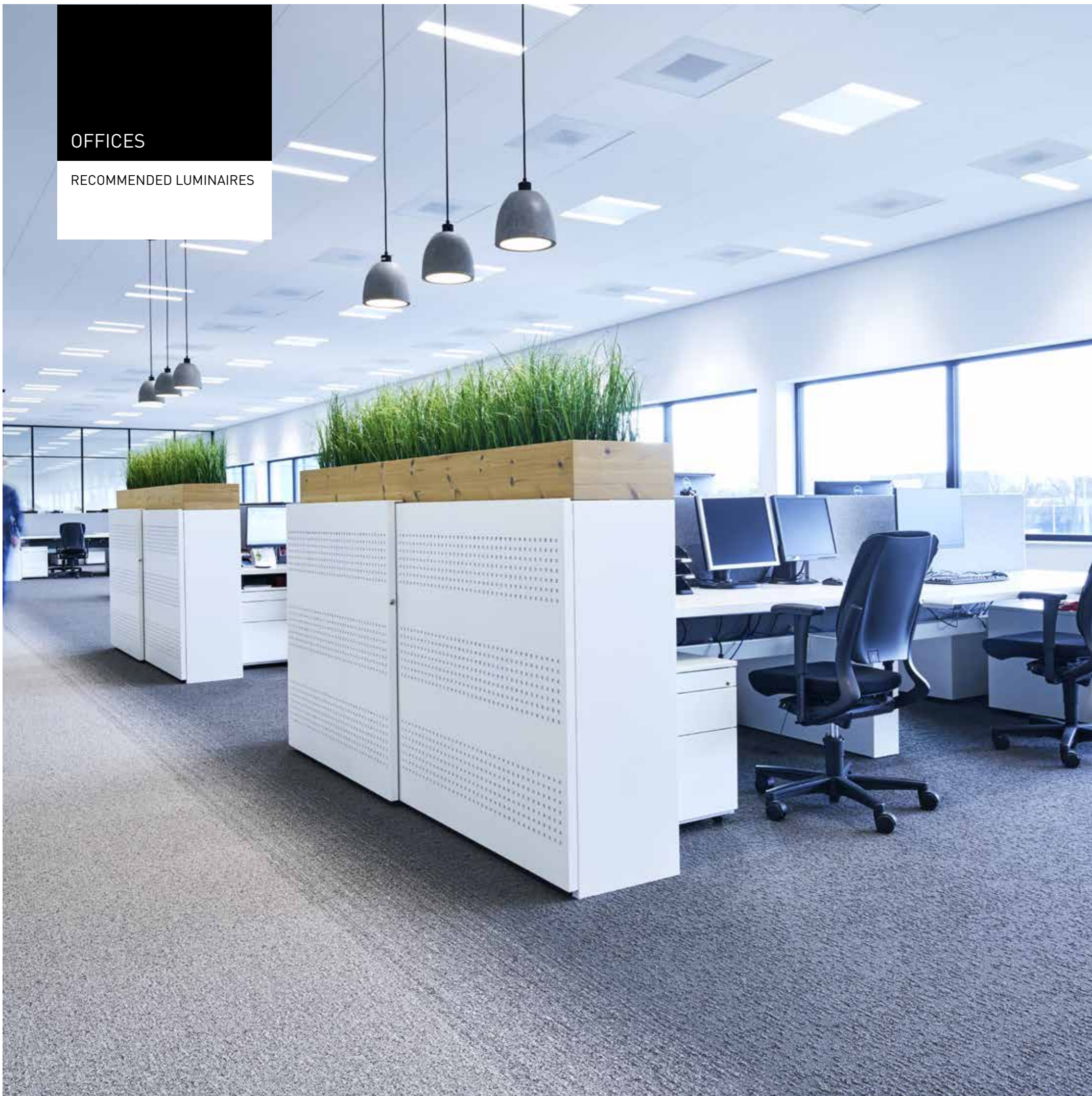

### Lateralo Plus

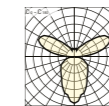

Mounting  
Luminous flux  
L. efficacy  
UGR  
Special feature

suspended  
6400-9600 lm  
126 lm/W  
<19  
transparent glass

### Lunexo

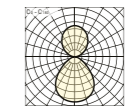

Mounting  
Luminous flux  
L. efficacy  
UGR  
Emergency

suspended  
6600-9000 lm  
111 lm/W  
<19  
Yes

### ArimoFit

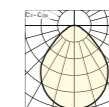

Mounting  
Luminous flux  
L. efficacy  
UGR  
Emergency

recessed  
3000-5200 lm  
136 lm/W  
<19  
Yes

### Parelia

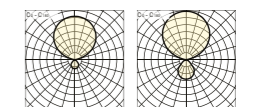

Mounting  
Luminous flux  
L. efficacy  
UGR  
Emergency

suspended  
11500+ lm  
105 lm/W  
<19  
No

# SECURITY ROOM

## RECOMMENDED LUMINAIRES

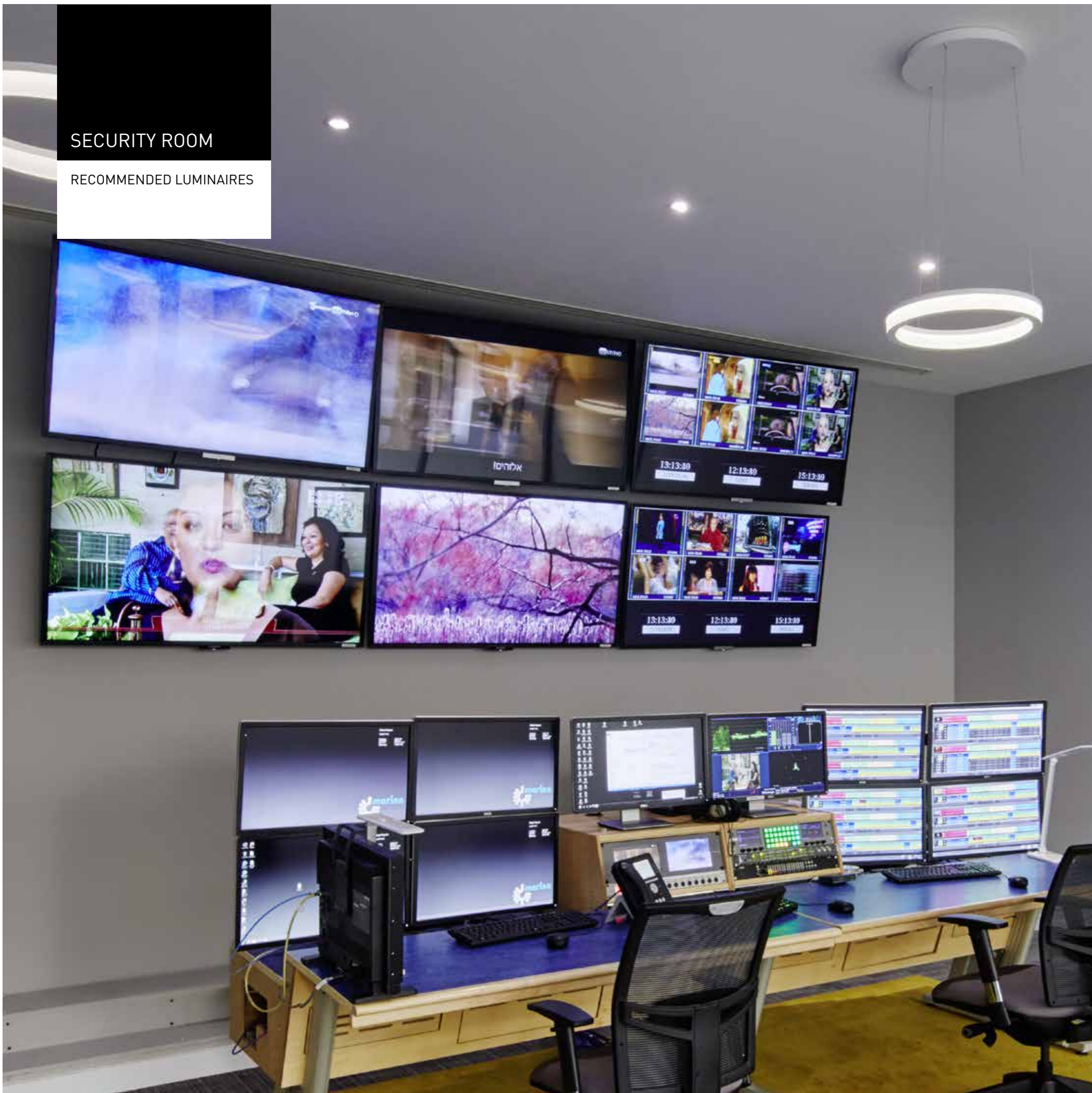

**Lunexo D**

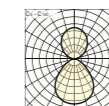

Mounting  
Luminous flux  
L. efficacy  
UGR  
Emergency

surface  
4400-5500 lm  
96 lm/W  
<19  
Yes

**Polaron IQ H**

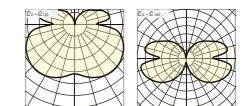

Mounting  
Luminous flux  
L. efficacy

suspended  
2000 lm  
118 lm/W

**ArimoFit**

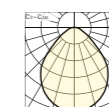

Mounting  
Luminous flux  
L. efficacy  
UGR  
Emergency

recessed  
3000-5200 lm  
136 lm/W  
<19  
Yes

**Sonnos**

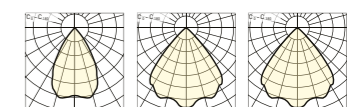

Mounting  
Luminous flux  
L. efficacy  
UGR  
Emergency

recessed  
1000-4000 lm  
130 lm/W  
<19, 22, 25  
Yes

# CORRIDORS

## RECOMMENDED LUMINAIRES

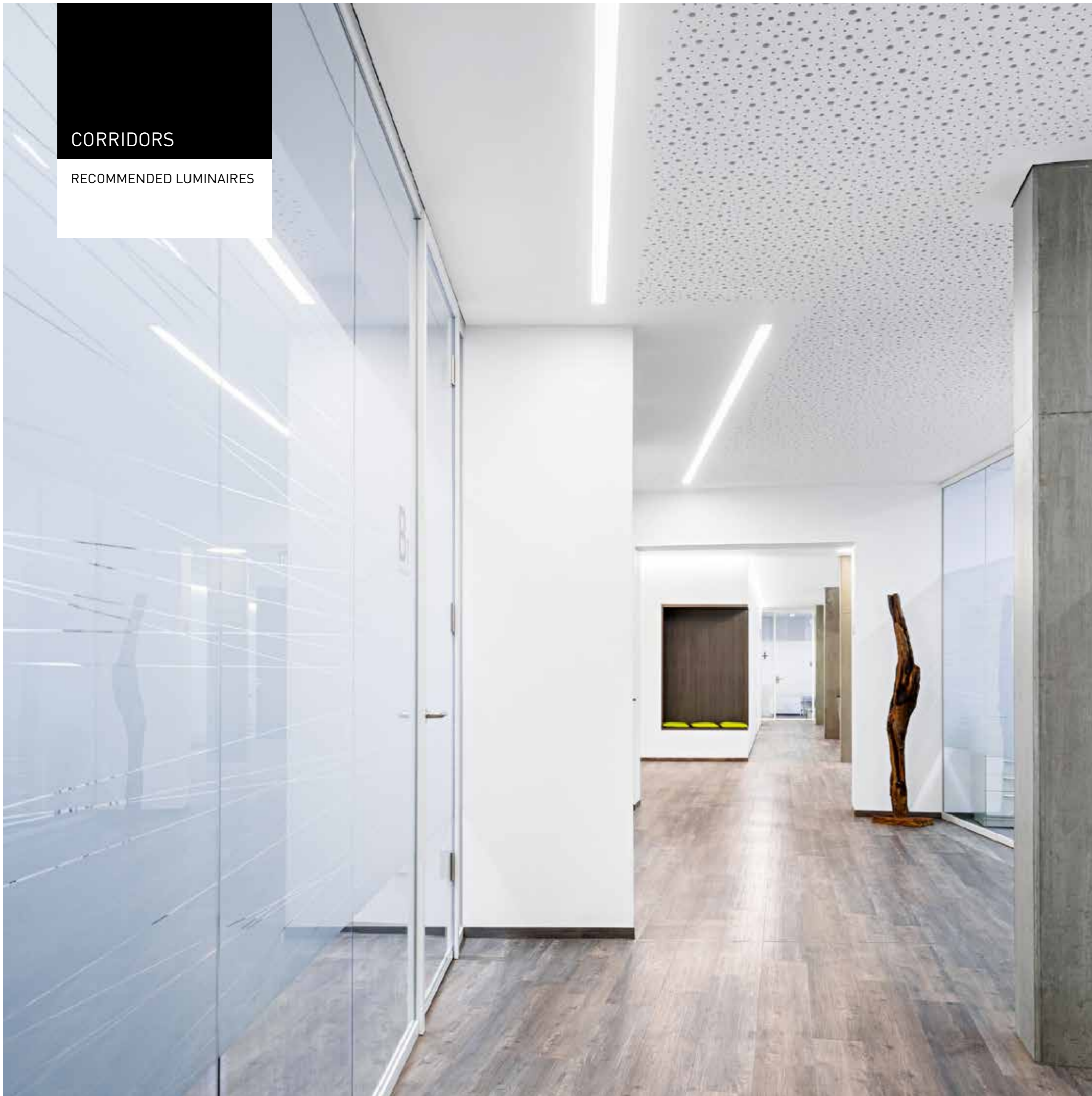

### Sonnos

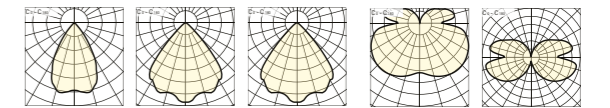

Mounting recessed  
Luminous flux 1000-4000 lm  
L. efficacy 130 lm/W  
UGR <19, 22, 25  
Emergency Yes

### Polaron IQ



Mounting wall  
Luminous flux 2000 lm  
L. efficacy 118 lm/W  
Emergency selected models

### Finea

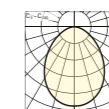

Mounting recessed  
Luminous flux 2300 lm/m  
L. efficacy 100 lm/W  
Emergency Yes

### Invego

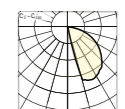

Mounting recessed  
Luminous flux 15-400 lm  
L. efficacy 34 lm/W  
Emergency No

# STAIRS

## RECOMMENDED LUMINAIRES

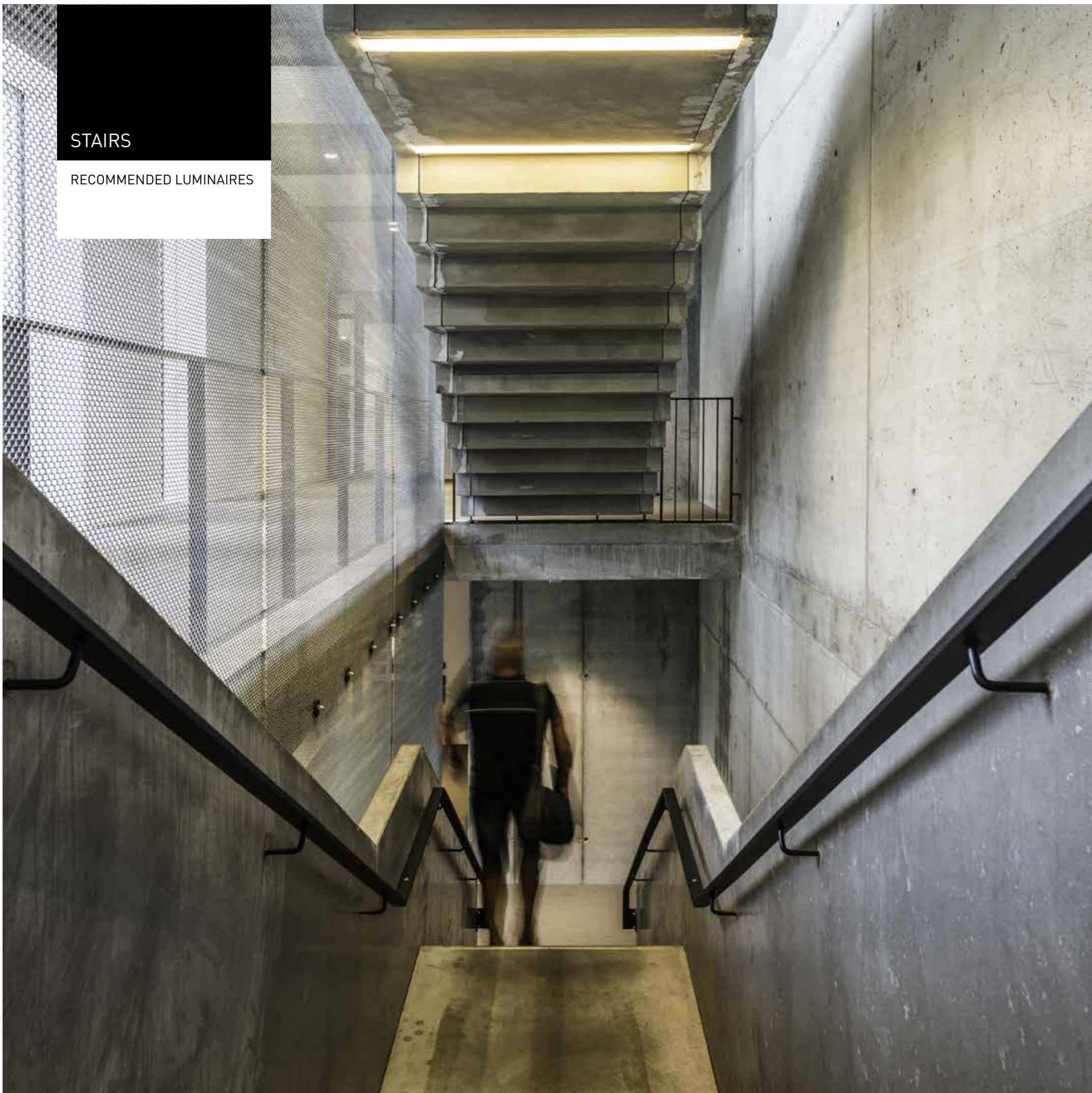

**Polaron IQ W**

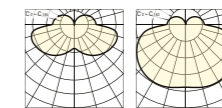

Mounting  
Luminous flux  
L. efficacy  
Emergency

wall/ceiling  
1800-3100 lm  
115 lm/W  
Yes

**74R**

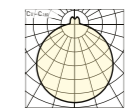

Mounting  
Luminous flux  
L. efficacy  
Emergency

wall/ceiling  
2200-3200 lm  
116 lm/W  
Yes

**Finea**

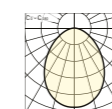

Mounting  
Luminous flux  
L. efficacy  
Emergency

recessed  
2300lm/m  
100 lm/W  
Yes

**Solvan Flow**

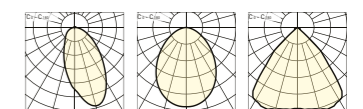

Mounting  
Luminous flux  
L. efficacy  
Emergency

ceiling  
4000 lm  
143 lm/W  
yes



# CANTEEN

## RECOMMENDED LUMINAIRES

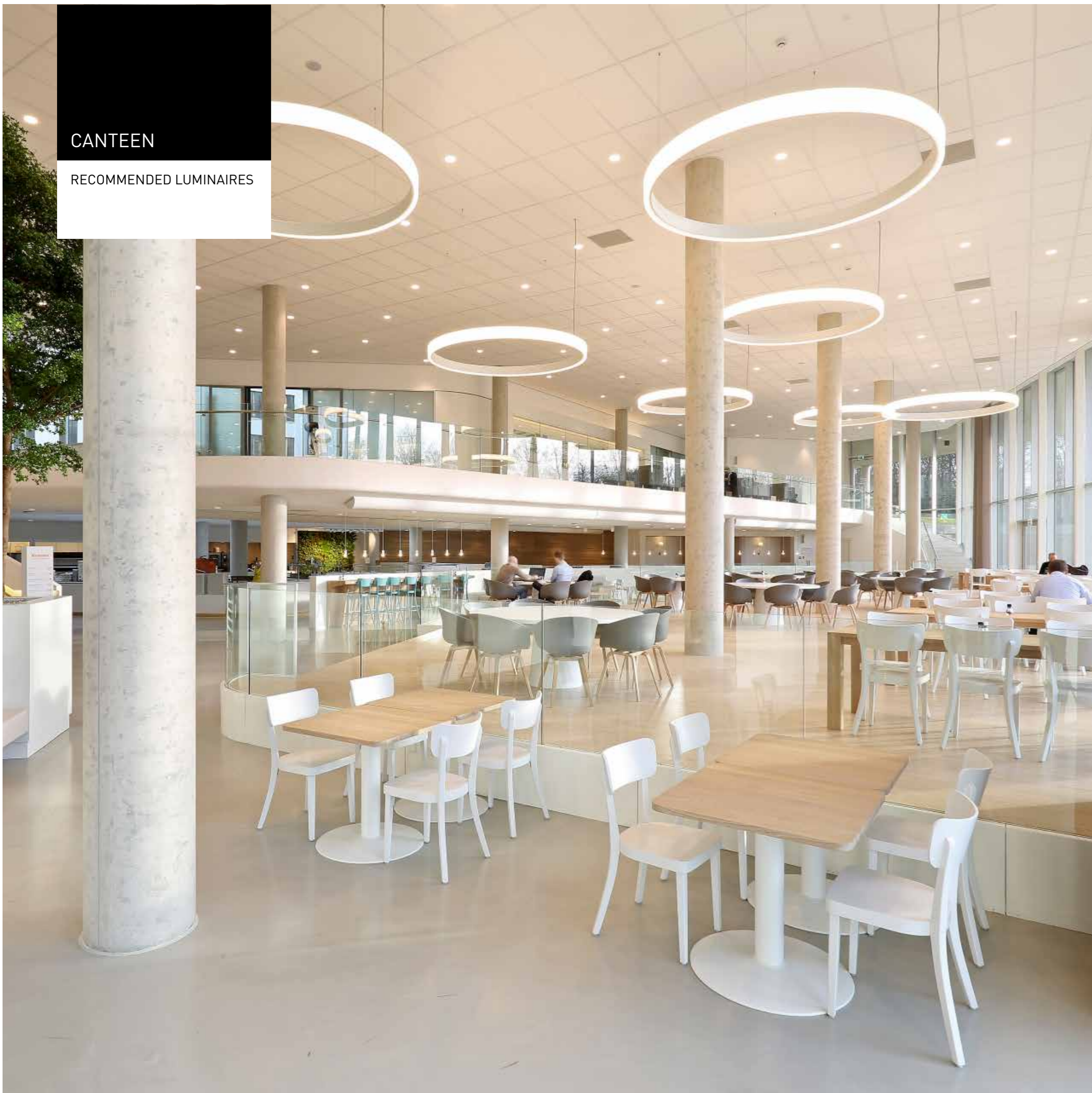

### Sonnos

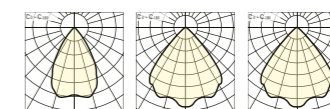

**Mounting** recessed  
**Luminous flux** 1000-4000 lm  
**L. efficacy** 130 lm/W  
**UGR** <19, 22, 25  
**Emergency** Yes

### Skeo Q

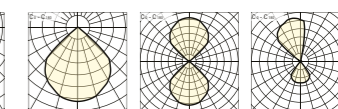
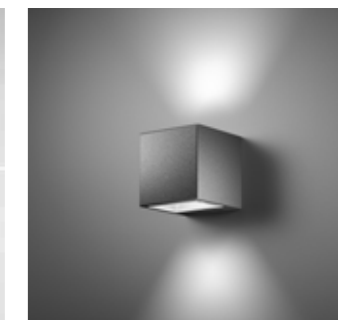

**Mounting** wall  
**Luminous flux** 40-3200 lm  
**L. efficacy** 114 lm/W  
**Protection** IP65

SANITARY FACILITIES

RECOMMENDED LUMINAIRES

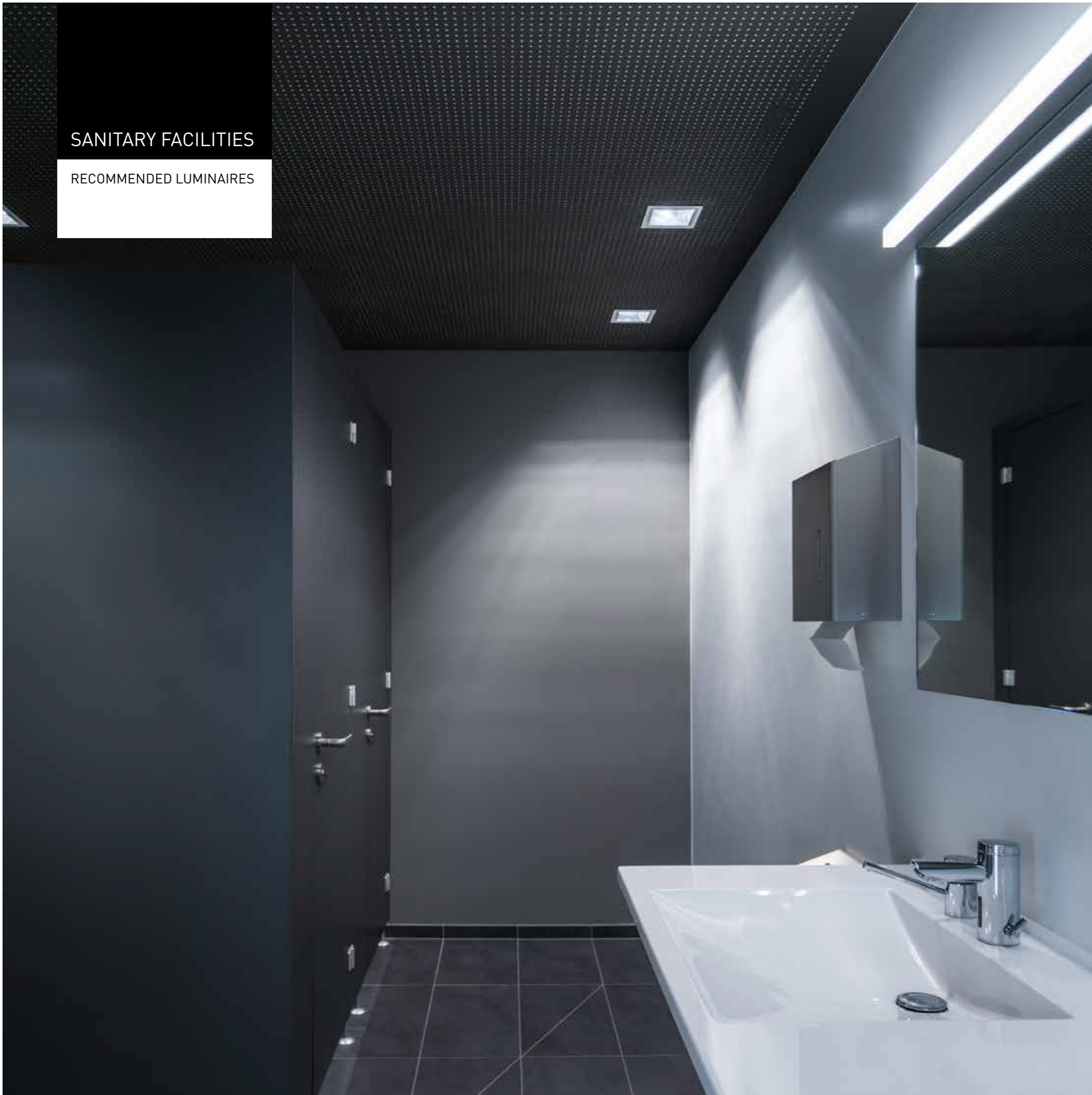

SNC Point

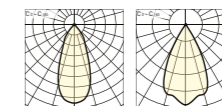

Mounting recessed  
Luminous flux 900-1300 lm  
L. efficacy 87 lm/W  
Emergency Yes

Sonnos

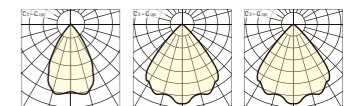

Mounting recessed  
Luminous flux 1000-4000 lm  
L. efficacy 130 lm/W  
UGR <19, 22, 25  
Emergency Yes

Finea

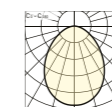

Mounting recessed  
Luminous flux 2300 lm/m  
L. efficacy 100 lm/W  
Emergency Yes

Acuro

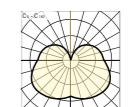

Mounting wall  
Luminous flux 1000 lm  
L. efficacy 125 lm/W  
Switch: socket available

OUTDOOR

RECOMMENDED LUMINAIRES

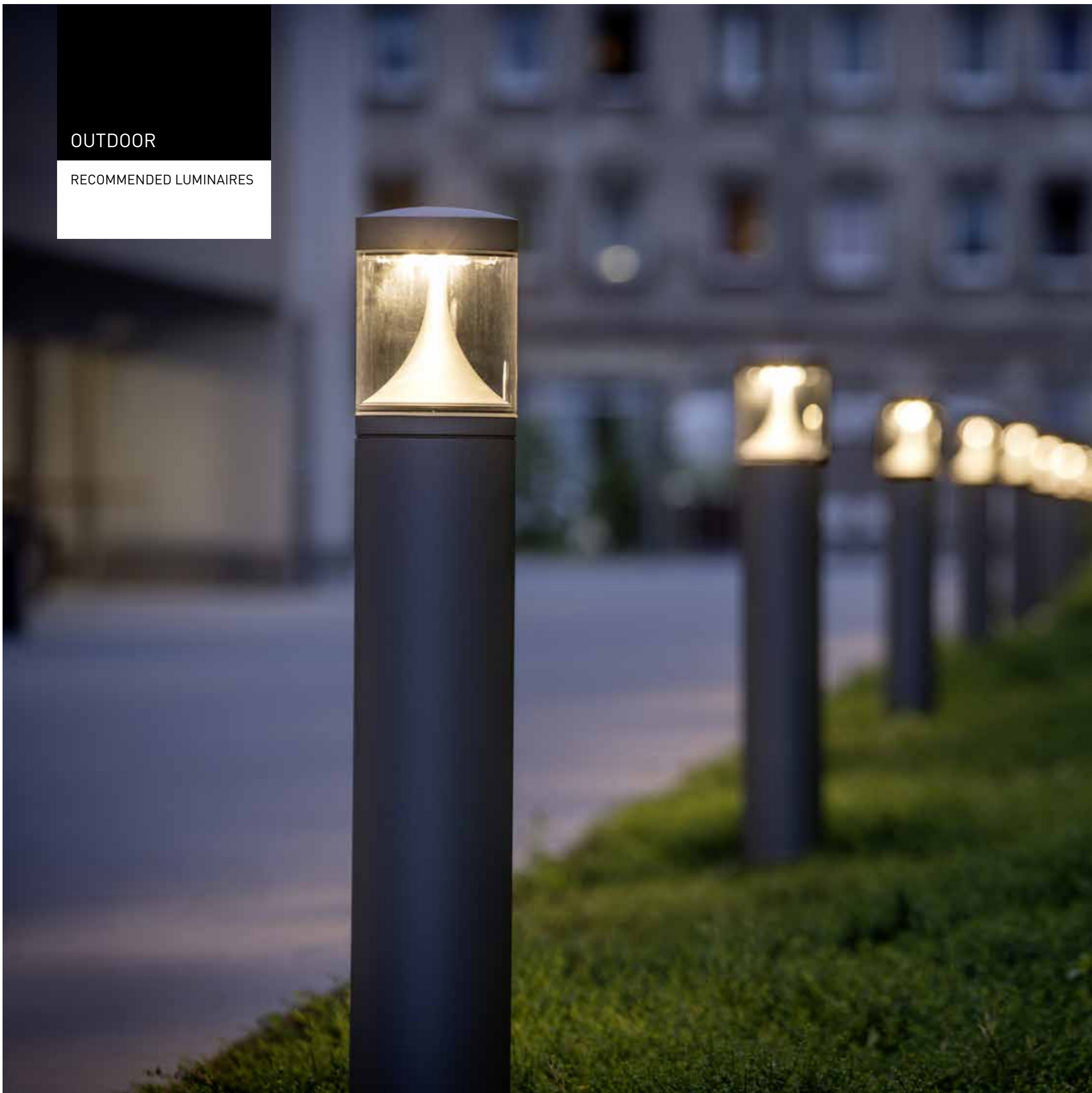

**Constela - Modular system**

Lighting



Spots



EV charging



Security



Speaker / WiFi / other modules are also available

**Publica**



**Jovie**

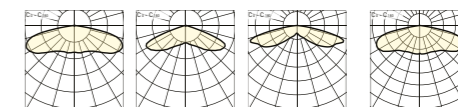

Application  
Luminous flux  
L. efficacy  
Protection

car park  
800-4600 lm  
103 lm/W  
IP66

Application  
Luminous flux  
L. efficacy  
Protection

road  
1000 - 24000 lm  
120 lm/W  
IP66

LIGHT AROUND  
THE BUILDING

RECOMMENDED LUMINAIRES

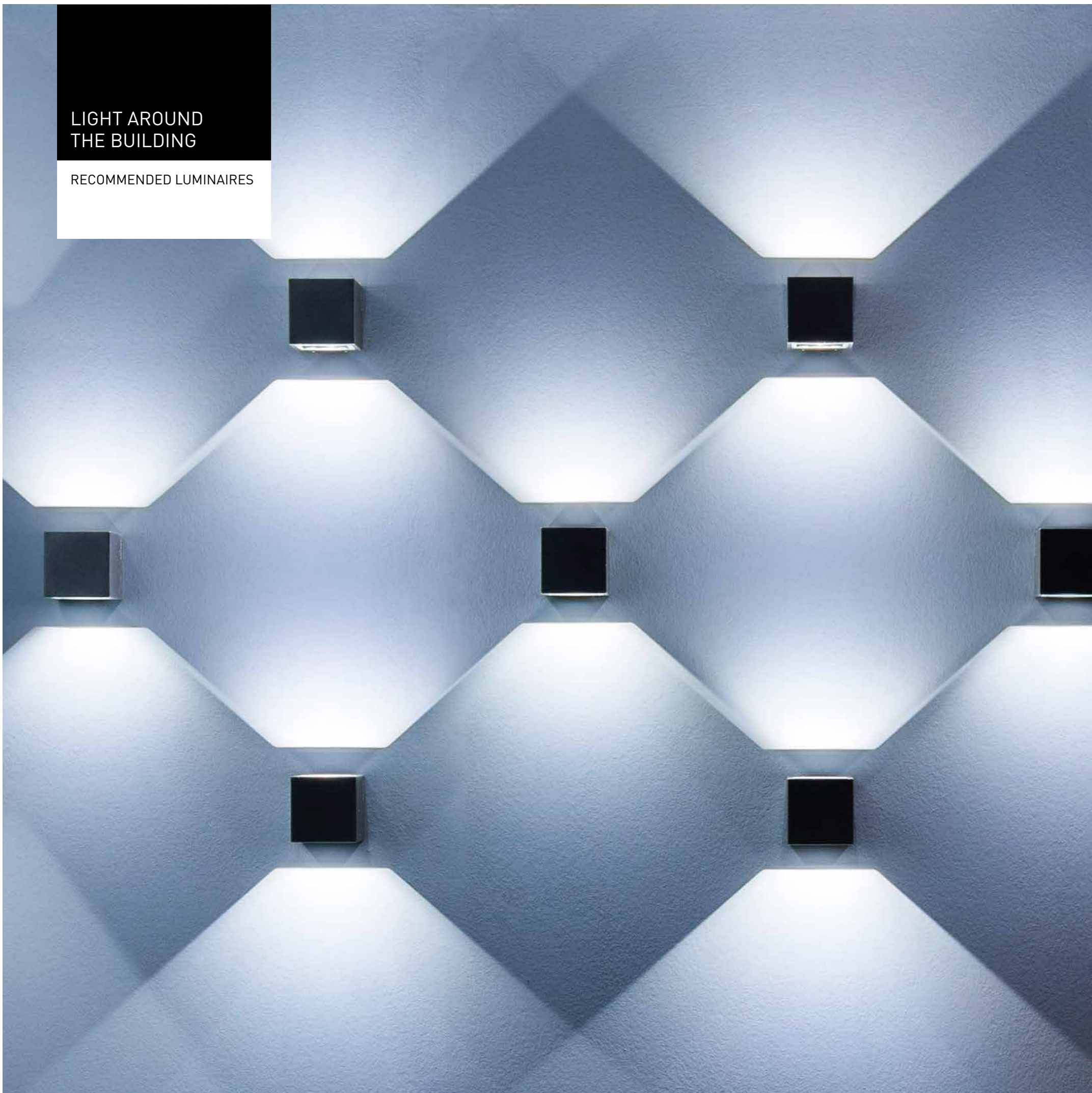

8841



Mounting  
Luminous flux  
L. efficacy  
Protection

Skeo Q/R

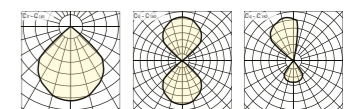

Mounting  
Luminous flux  
L. efficacy  
Protection

SDEL

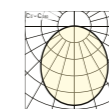

Mounting  
Luminous flux  
L. efficacy  
Protection

SABR

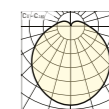

Mounting  
Luminous flux  
L. efficacy  
Protection

EMERGENCY LIGHTING

RECOMMENDED LUMINAIRES



Bulkheads



EBP Surface

Exit Signs



ESP Mini Recessed Circular Cutout



ESP Recessed Circular Cutout



ESP Recessed



ESP Recessed Suspended



ESP Surface



ESP Surface Suspended



ESP Wall



ESP Wall Arm



ESC Recessed



ESC Surface



ESC Suspended



ESC Wall

Route



ERP Wall Recessed



ERP Surface Linear



ERP Recessed

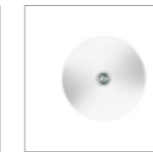

ERP Surface Round



ERP Surface Square



ERC Recessed



ERC Surface

Twin Head



EHC Twin Head

Track



ETP Track Mounted

		IP Rating	Maintained/ non-maintained	3 Hr Self Contained	Central Battery	DALI Self Test	Viewing Distance
<b>Bulkheads</b>	EBP Surface	IP65	✓	✓	✓		n/a
<b>Exit Signs</b>	ESP Mini Recessed Circular Cutout	IP20	✓	✓	✓		15m
	ESP Recessed Circular Cutout	IP20	✓	✓	✓		22m
	ESP Recessed	IP20	✓	✓	✓		22m
	ESP Recessed Suspended	IP20	✓	✓	✓		22m
	ESP Surface	IP40	✓	✓	✓		22m
	ESP Surface Suspended	IP40	✓	✓	✓		22m
	ESP Wall	IP40	✓	✓	✓		22m
	ESP Wall Arm	IP40	✓	✓	✓		22m
	ESC Recessed	IP40	✓	✓		✓	22m
	ESC Surface	IP41	✓	✓		✓	22m
	ESC Suspended	IP41	✓	✓		✓	30m
	ESC Wall	IP40	✓	✓		✓	30m
	<b>Route</b>	ERP Wall Recessed Route	IP65	✓	✓		
ERP Surface Linear Route		IP54	✓	✓			n/a
ERP Recessed		IP54	✓	✓		✓	n/a
ERP Surface Round		IP20	✓	✓		✓	n/a
ERP Surface Square		IP20	✓	✓		✓	n/a
ERC Recessed		IP20	✓	✓		✓	n/a
ERC Surface		IP20	✓	✓		✓	n/a
<b>Twin Head</b>	EHC Twin Head	IP65	✓	✓		✓	n/a
<b>Track</b>	ETP Track Mounted	IP20	✓	✓		✓	n/a

**Emergency luminous flux of luminaires with integral emergency kits**

Ballast Lumen Factor is the ratio of the light output of the LED light engine or luminaire in emergency operation compared with the light output of the same LED light engine operated at normal lighting conditions. Please refer to the appropriate LED light engine pages for actual BLF values.

Connected load	BFL
5 W	60%
7 W	43%
9 W	34%
10 W	30%
12 W	25%
14 W	22%
15 W	21%
16 W	19%
17 W	18%
18 W	17%
19 W	16%
20 W	15%
22 W	14%
24 W	13%
25 W	12%
28 W	11%
30 W	10%
35 W	9%
40 W	8%
45 W	7%
50 W	6%
60 W	5%

**High temperature lithium polymer batteries**

Accelerated lifetime tests data on LiFePO 4 batteries show that the operational life of these cells is double the operational life of traditional emergency lighting batteries. In addition to this, the extremely low self discharge of this chemistry dramatically reduces the power consumption under use. For example, NiCd batteries have a power consumption of 5W, where equivalent LiFePO4 batteries have an average power consumption of 1.2W. Features:

- Extra long life chemistry
- Much lower power consumption than other batteries
- 5°C to 60°C Tc 5 - 50°C Ta

**Conventional batteries**

Nickel Cadmium (NiCd) and Nickel Metal Hydride (NiMH) batteries are cost effective solutions however they provide shorter lifetime when compared to Lithium batteries.

Nickel Cadmium (NiCd): 5°C to 50°C Tc - 25°C Ta

Nickel Metal Hydride (NiMH) : 5°C to 50°C Tc - 25°C Ta

## CENTRAL BATTERY SYSTEM

SOLUTION FOR LARGE SCALE EMERGENCY LIGHTING



Central battery system based emergency lighting is ideal for medium to large installations. For projects where central control and testing is desirable, a central battery system is a viable and cost effective alternative to self-contained emergency lighting products.

The main advantages of central battery systems over self-contained systems are:

- Testing and maintenance are much easier to carry out
- Battery replacement is much quicker and less disruptive
- Battery compartments/ room can be easily maintained at optimum temperature
- Battery life is generally 10 years or more
- Luminaires can be centrally controlled
- High light levels can easily be achieved
- The emergency lighting system can be completely unobtrusive
- E Line system has fire rating certification approval for simplified emergency wiring

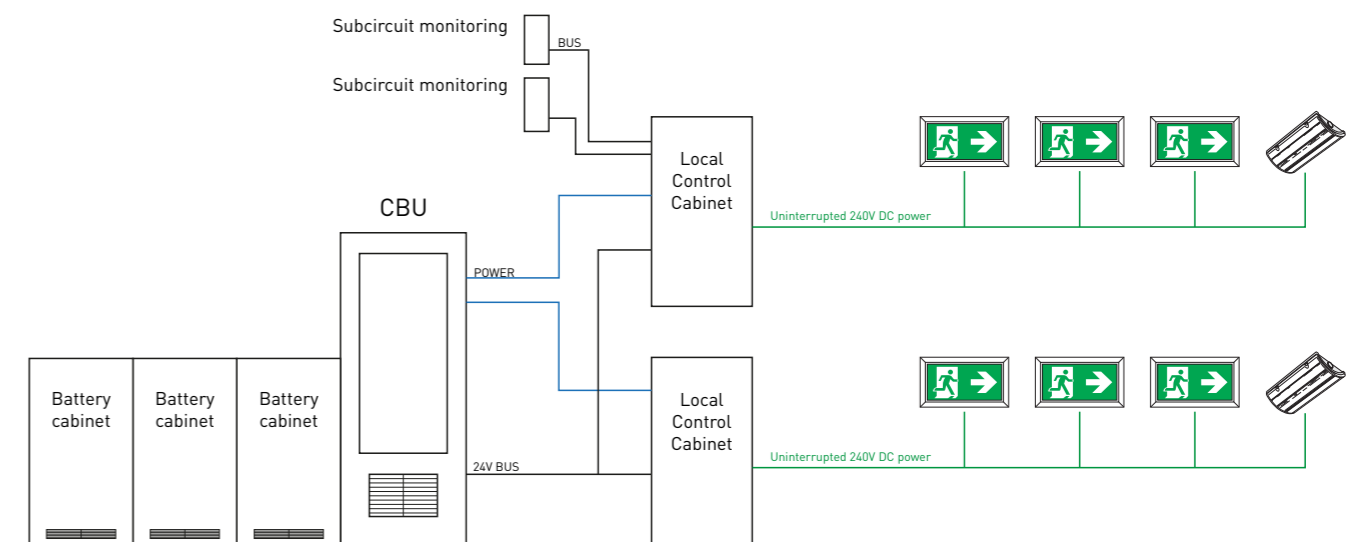

## KEY FACTS & SERVICES

FACTS SPEAK VOLUMES

over  
**100**  
years old

**5200**  
employees

**1.7** million  
luminaires  
manufactured  
per year

**1st**

in Germany

**3rd**

in Europe

**7**

production sites

**50**

countries



## QUALITY

MADE BY TRILUX



German engineering, customised solutions and innovative designs. TRILUX offers not only standard solutions, but in close cooperation with the customer develops atmospheric and simultaneously functional lighting concepts complying to current standards. This is ensured by premium materials, in-house developed optics, extensive data records and outstanding efficiency levels.

### PRODUCT QUALITY



TRILUX represents customer specific configurations, and develops products with and for its customers oriented precisely to their needs. As such, TRILUX offers market-compliant and future-proof lighting solutions matched to the specific requirements of the various applications.

### DESIGN QUALITY



TRILUX lighting concepts adapt to the overall architectural concept of a building, complementing the architecture with good lighting. We develop our products in close cooperation with renowned lighting designers, and such products are regularly distinguished by winning design awards.

### LIGHT QUALITY

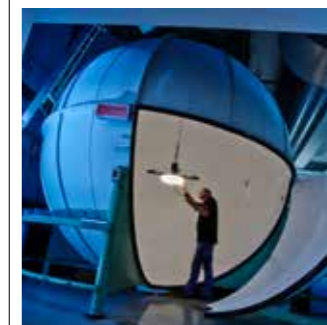

TRILUX lighting solutions offer much more than just lighting compliant to standards. They can be adapted individually to very different needs, supporting the users in their daily work tasks.

### DATA QUALITY



TRILUX accompanies and drives forward the transformation in planning of buildings with BIM by providing extensive product documentation. Such documentation leads the way in the industry.



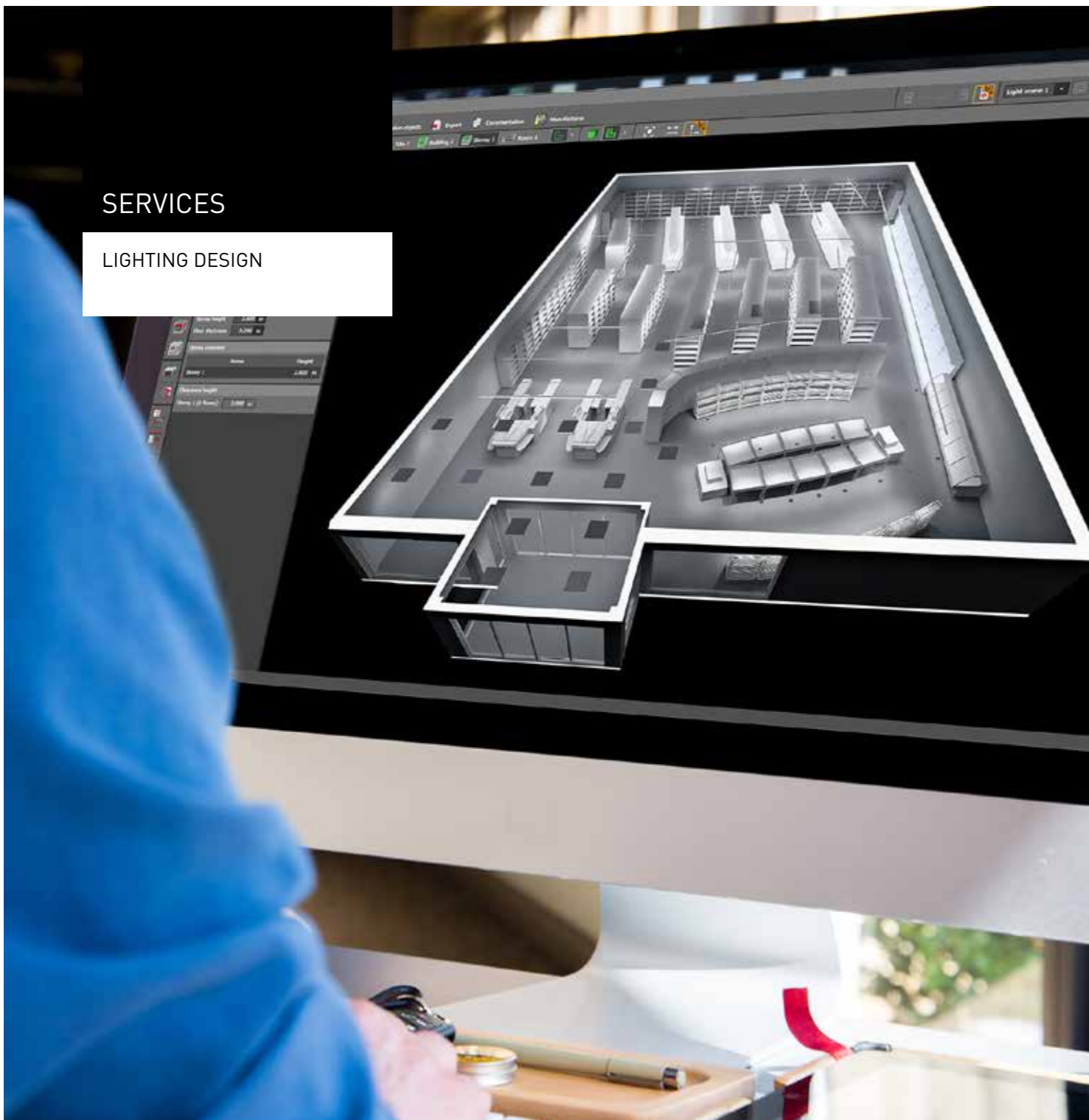

### Lighting Concepts & Analysis

We offer a detailed lighting analysis. Our analysis reveals hidden improvement and provides you with a first impression of how we can work together. Our experts' wide range of experience in implementing light concepts ensures that the approved concept will be successfully integrated within the individual architecture.

TRILUX lighting solutions offer much more than just lighting compliant to standards. They can be adapted individually to very different needs, supporting the users in their daily work tasks. In close cooperation with the customer TRILUX develops atmospheric and simultaneously functional lighting concepts complying to current standards.

### LED Future Proofing

Any future enhancements or improvements in LED technology will continue to be phased into our luminaires providing the customer with the most efficient and technologically advanced product at no extra cost. This will ensure that your products will be future proofed for the duration of the project installation. As your incumbent lighting partner we would show any new lighting technology ahead of the market.

### Packaging

A key objective of our waste management strategy is to reduce the levels of packaging used to protect the products during storage and transit. In line with this objective, our Packaging Designers aim to produce designs for effective packaging with minimal waste. For major projects the designers have replaced individual cartons with re-useable polypropylene trays with foam inserts that accept multiple fittings at a time. Additionally, a 90% reduction in polystyrene filler pads has been recorded as a result of air bags made on-site.

### Environmental Product Declarations

We practice Eco Design for all new products. Eco Design considers the environmental impacts of the product during its lifetime – from its manufacture, operation and its final dismantling and recycling of its component materials. This approach ensures that care is taken during design to employ the minimum amount of restricted hazardous substances and that the minimum amount of virgin materials, water and energy are used during manufacture.

### WEEE Directive

TRILUX UK comply fully with the requirements of the WEEE directive. We take responsibility to arrange the collection, recycling and disposal of our luminaires.



**Various possibilities and extensive advice**

Together with you we draw up your ideal financing solution.

Balance-neutral realisation of lighting projects without own investments: greater scope for action by protecting your equity capital.

- Renting only the light actually needed on a monthly basis.
- Terminable leasing
- Cancellable operating leasing
- Fixed-term leasing
- Installment purchase
- Contracting –Service & Sales & Warranty
- Transfer of ownership, where appropriate expiration of contract with termination arrangement]

At TRILUX we also understand the difficulties with Tenant & Landlord scenarios, that can influence the Payback periods vs Financing options, in relation to Lease periods.

**We give you 5 years guarantee!**

We have been guaranteeing our products for over 100 years. The quality of our products and the satisfaction of our customers is of primary importance to us. For this reason TRILUX provides a guarantee of 5 years.

In the unlikely event of a product becoming faulty, we have a dedicated Customer Care team, who will be able to resolve and rectify the problem. The team are highly experienced with a wealth of product knowledge, enabling them to provide our customers with all the advice and support they require.

The guarantee comes into effect simultaneously with the purchase contract based on the applicable guarantee conditions.



## Premium components

The source of LEDs is particularly decisive for quality and service life of the light.

## Perfect light control

Only with precise light control the advantage of LEDs can be fully used.

## Light stability and light colour

During planning, light colour and light stability over the service life should definitely be taken into account.

## TRILUX TIP LED and design – complete flexibility with form and colour

LEDs with a diameter of 0.5 mm, flexible LED modules that can be integrated as bands, chains or surfaces into luminaires and 16.7 million colours – never before have luminaire designers had such flexibility with forms and colour design. TRILUX uses this creative freedom mainly for one thing: to construct luminaires that are both so innovative and attractive that they deserve design awards and so powerful and energy-efficient that they inspire in practice.

## Design-awarded LED luminaires



To see the full list of our award winning luminaires.



## Binning of LEDs – what the eye sees...

To sort LEDs it would theoretically be a good idea to define a desired colour value in the CIE system and to assign this a circular tolerance radius. Testing in practice though shows that the human eye perceives different colour deviations to different extents. While it perceives relatively small differences in the blue-violet range, perception in the green range for example is poorer.

**Note:**  
The figure shows no 1-SDCM MacAdam ellipses but enlargements to more clearly explain the principle.

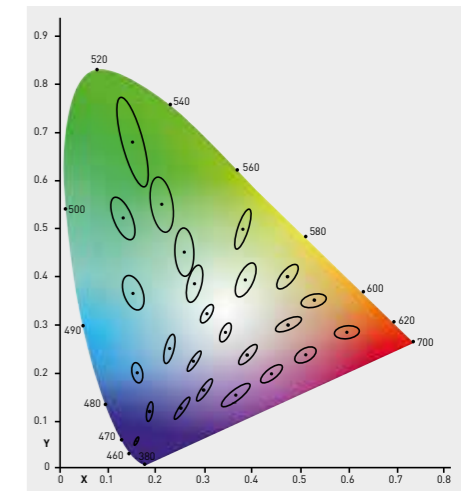

## LED binning – MacAdam ellipses

This phenomenon is taken into account by MacAdam ellipses. According to the definition, a MacAdam ellipse is the extent around a colour tone in which the observer has the impression that all comparative colours have the same distance from the reference colour tone. The dimensions in which the MacAdam ellipses are specified are SDCM (Standard Deviation of Color Matching) or threshold value units. If the ellipse is small enough, e.g. SDCM = 1, the colours within the ellipse are perceived to be equal.

## White LEDs in full distribution



With a full distribution solution, the LEDs jointly integrated into a luminaire are not binned and the emitted light has visible colour differences.

## Dimensions of the MacAdam ellipses in SDCM

Size of MacAdam ellipse	1 SDCM / Single distance	2-3 SDCM / 2-3 fold distance	> 4 SDCM / > 4-fold distance
Quality of colour homogeneity in the ellipse	No visible colour deviation	Hardly any visible colour deviation	Visible colour deviation

The luminous flux of LED light sources also decreases with increasing operating duration. This phenomenon is referred to as luminous flux degradation. However, total failures of LED light sources only occur after a extensive period of time when the degradation is far advanced. Therefore, total failure plays only a minor role when considering the service life of this type of LED products.

## Failure rate AFV Total failure time $C_y$

The AFV failure rate ('abrupt failure fraction') specifies the percentage quantity of LED luminaires that totally failed up to the time of nominal rated service life  $L_x$  (at  $B_{50}$ ). If the failure rate of LED luminaires is practically non-existent up to the rated service life, it is usually not specified.

The total failure time  $C_y$  is specified as  $B_{50}$  for all other  $B_y$  values, and specifies the time after which  $y$  % of the LED luminaires have totally failed. The index value  $y$  in  $C_y$  in this case is not necessarily comparable with the index  $y$  in  $B_y$ .

If LED luminaires consist of several LEDs or LED modules, the total failure of LED luminaires does not relate to the failure of individual LEDs or LED modules.

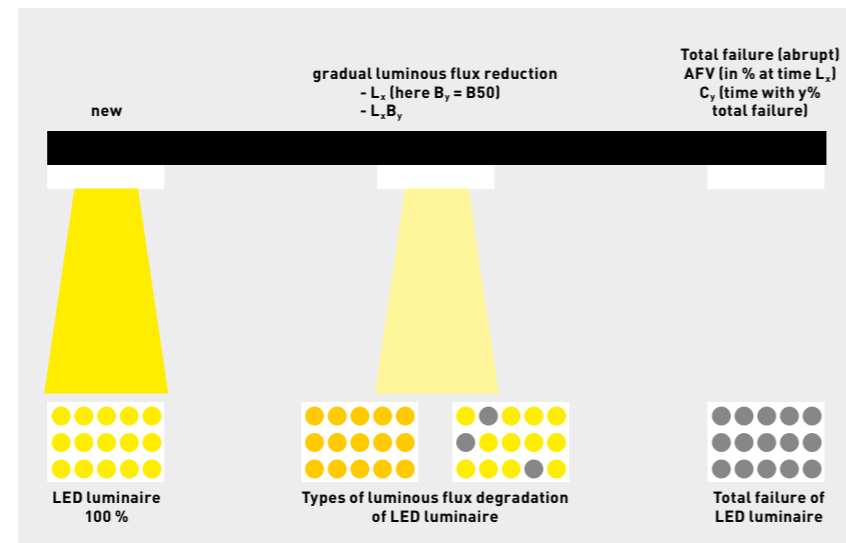

## Rated service life $L_x B_y$ Nominal rated service life $L_x$

The definition of "average rated service life"  $L_x$  is common on the market, without specification of  $B_y$ . In this case, it is assumed that the index  $y$  of the general definition is 50. Therefore,  $L_x$  refers to the statistic average of the residual luminous flux remaining at the end of service life for a large number of luminaires.

The service life specification; 50,000h @ L80 for a given luminaire, e.g. means that a large number of these luminaires in total after 50,000 operating hours still generate at least 80% of their rated luminous flux (available initially and in total). Therefore, this is an average value.

Until the rated service life is reached, the progress of the drop in luminous flux (degradation) can be regarded as linear in simplification (see figure ).

Service Life's are rated at a given temperature, if the project operating temperature, is different to that of the LED luminaire, then this can increase or decrease the rated Luminous flux over life. eg 75,000h @

L80B50@35C = 148,000h @L80B50 @25C = 210,000h @L80B50 @15C

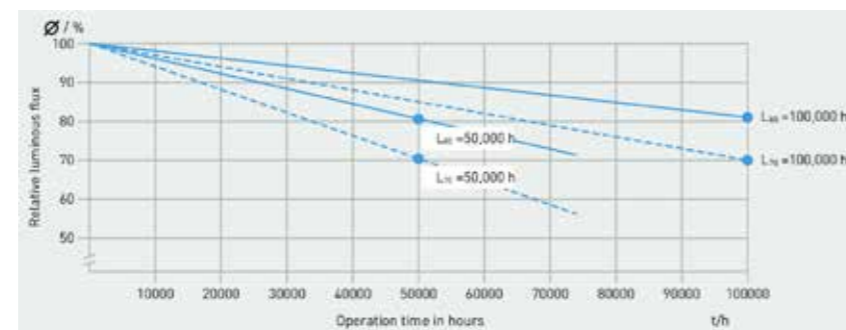

## Nominal rated life cycles in comparison

It is only possible to compare LED luminaires with regard to service life by specifying the nominal rated service life  $L_x$  and the total failure AFV. The quantity of total failures up until the nominal rated service life of quality-manufactured LED luminaires is usually very low. Attention should be paid to total failure when specifying the products, but this plays almost no role when observing luminaire classifications. Products become comparable with the categorising of LED luminaires into corresponding luminaire classifications (e.g. L80 - 50,000 hrs.).

Luminaire classification of LED luminaire	Conversion into other luminaire classifications		
	L85	L80	L70
L85 - 50,000 h	50,000 h	67,500 h	100,000 h
L80 - 50,000 h	37,500 h	50,000 h	75,000 h
L70 - 50,000 h	25,000 h	33,500 h	50,000 h

## Industry-leading thermal and electric management

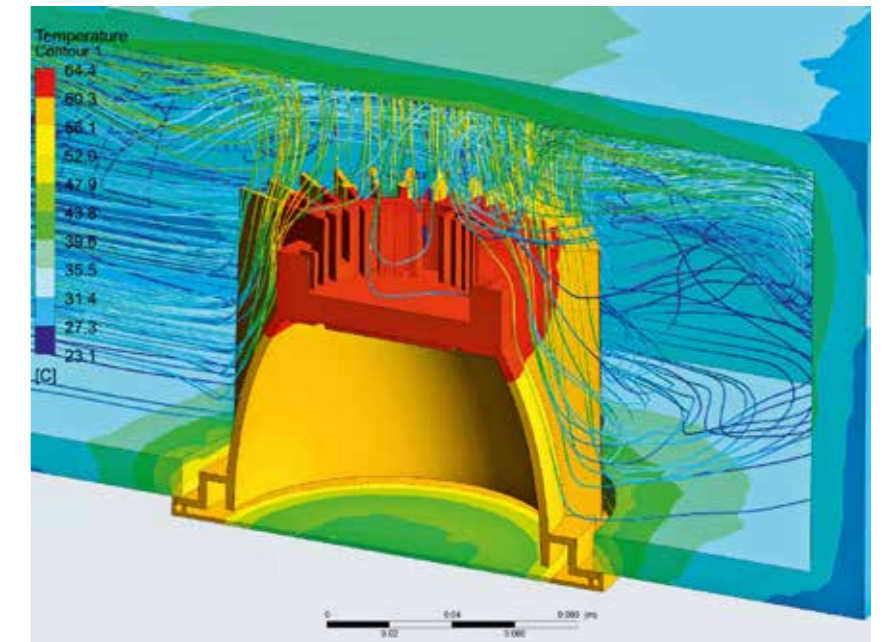

In order for LEDs to fully leverage on their advantages in terms of service life and luminous efficiency they must be operated at the ideal operating point. For this, excellent thermal and electrical management is mandatory. TRILUX optimises the thermal chain of its luminaires via detailed simulations and constructions on the real system. Factors considered include the total power consumption of the luminaire, the ambient temperature in the application, the air flow around the luminaire, the required luminous efficiency of the LED and the targeted service life.

**TRILUX GmbH & Co. KG**

Heidestraße · D-59759 Arnsberg  
Postfach 19 60 · D-59753 Arnsberg  
Tel. +49 29 32.3 01-0  
Fax +49 29 32.3 01-3 75  
sales@trilux.com  
www.trilux.com

**TRILUX Vertrieb GmbH**

Key Account Management  
Heidestraße 4 · D-59759 Arnsberg  
Tel. +49 29 32.3 01-44 96  
Fax +49 29 32.3 01-49 70  
kam@trilux.com  
www.trilux.com

**TRILUX LIGHTING LIMITED**

TRILUX HOUSE, Winsford Way  
Boreham Interchange  
Chelmsford, Essex  
CM2 5PD  
Tel. +44 12 45.46 34 63  
Fax +44 12 45.46 26 46  
info.co.uk@trilux.com  
www.trilux.com

All technical data including dimensional and weight specifications have been checked carefully. Errors excepted. Possible colour deviations are due to printing processes.

We reserve the right to modify in the interest of progress. Luminaires are partly shown with accessories that must be ordered separately. Images of installations may show custom manufactured luminaires.

Printed on PEFC-certified paper in an environmentally friendly way.

